

# Product Overview

03/2014

P00013U1K01



## RS 310-410-510-610 Series

Modulating Gas Burners

RS 310/M-/E -/EV BLU	400/1200 ÷ 3630 kW
RS 410/M-/E -/EV BLU	500/1500 ÷ 4450 kW
RS 510/M-/E -/EV BLU	680/1800 ÷ 5250 kW
RS 610/M-/E -/EV BLU	1000/2200 ÷ 6250 kW
RS 310/M-/E -/EV MZ	600/1300 ÷ 3900 kW
RS 410/M-/E -/EV MZ	800/2000 ÷ 4900 kW
RS 510/M-/E -/EV MZ	802/2200 ÷ 5520 kW
RS 610/M-/E -/EV MZ	820/2400 ÷ 6300 kW

  
Energy For Life

## Overview

The high power monoblock Burners Series RS, are the result of intensive activities of technical research and considerable investments, carried out in recent years, that allowed the highest levels of technological development to be achieved in the Industrial Burners context, confirming the historical leadership of Riello in this important area of energy management.

The remarkable results of performance, quality and reliability, are now consolidated by the creation of new models in the 3-6 MW range, RS 310-410-510-610, able to summarize and concentrate the best technological expertise of Riello.

The RS 310-410-510-610 burners series covers a firing range from 1200 to 6300 kW, and it has been designed for use in low or medium temperature hot water boilers, hot air or steam boilers, diathermic oil boilers.

Operation can be "two stage progressive" or, alternatively, "modulating".

The new RS 310-410-510-610 burners series is available in yellow and low NO<sub>x</sub> flame and in various air-fuel ratio control configurations; Modulating Operation can be managed through Mechanical Cam for a simple commissioning, through Electronic Cam for higher performance and efficiency and through Variable Speed Drive technology to obtain both low noise emissions and electrical power saving.

The exclusive design ensures reduced dimensions, simple use and maintenance.

A wide range of accessories guarantees elevated working flexibility.



## Burner Models

MODELS	FUEL		OPERATION				EMISSIONS	
	GAS	/M	/E	/EV	FS1	FS2	CLASS 3 EN 676	CLASS 2 EN 676
RS 310/M BLU	•	•			•(1)	•(2)	•	
RS 410/M BLU	•	•			•(1)	•(2)	•	
RS 510/M BLU	•	•			•(1)	•(2)	•	
RS 610/M BLU	•	•			•(1)	•(2)	•	
RS 310/E BLU	•		•		•(3)	•(4)	•	
RS 410/E BLU	•		•		•(3)	•(4)	•	
RS 510/E BLU	•		•		•(3)	•(4)	•	
RS 610/E BLU	•		•		•(3)	•(4)	•	
RS 310/EV BLU	•			•	•(4)	•(4)	•	
RS 410/EV BLU	•			•	•(4)	•(4)	•	
RS 510/EV BLU	•			•	•(4)	•(4)	•	
RS 610/EV BLU	•			•	•(4)	•(4)	•	
RS 310/M MZ	•	•			•(1)	•(2)		•
RS 410/M MZ	•	•			•(1)	•(2)		•
RS 510/M MZ	•	•			•(1)	•(2)		•
RS 610/M MZ	•	•			•(1)	•(2)		•
RS 310/E MZ	•		•		•(3)	•(4)		•
RS 410/E MZ	•		•		•(3)	•(4)		•
RS 510/E MZ	•		•		•(3)	•(4)		•
RS 610/E MZ	•		•		•(3)	•(4)		•
RS 310/EV MZ	•			•	•(4)	•(4)		•
RS 410/EV MZ	•			•	•(4)	•(4)		•
RS 510/EV MZ	•			•	•(4)	•(4)		•
RS 610/EV MZ	•			•	•(4)	•(4)		•

/M = Two stage progressive - Modulating mechanical cam

/E = Two stage progressive - Modulating electronic cam

/EV = Modulating electronic cam - Variable speed

FS1 = Intermittent (at least one stop every 24 h)

FS2 = Continuous

(1) = RMG .../M (or LFL ...) control box

(2) = LGK ... control box

(3) = REC27 ... control box

(4) = REC37 ... control box

## Technical Data

### LOW NO<sub>x</sub> FLAME MECHANICAL CAM VERSIONS

MODEL		RS 310/M BLU	RS 410/M BLU	RS 510/M BLU	RS 610/M BLU
Burner operation mode		Modulating			
Modulation ratio at max. output		5 ÷ 1			
Servomotor	type	SQM 40			
Heat output	kW	400/1200÷3630	500/1500 ÷4450	680/1800÷5250	1000/2200÷6250
	Mcal/h	344/1032÷3122	430/1290÷3827	585/1548÷4515	860/1892÷5375
Gas pressure at max. output (G20-G25)	mbar	50.1/74.7	53.1/79.2	59.7/89.1	77.6/115.8
Working temperature	°C min./max.	0/50			
Fan	type	Forward curve blades			
<b>ELECTRICAL DATA</b>					
Start up	Type	Direct			-
Electrical supply	Ph/ V/Hz	3N ~ 230 - 400V ±10% 50 Hz			-
Total electrical power	kW Max	9.1	10.8	-	-
Motor electrical power	kW	7.5	9.2	-	-
	A	23.9 - 13.8	29.3 - 16.9	-	-
Start up	Type	Star - Delta			-
Electrical supply	Ph/Hz/V	3N ~ 400 - 690V ±10% 50 Hz			-
Total electrical power	kW Max	9.1	10.8	14	17
Motor electrical power	kW	7.5	9.2	12	15
	A	13.8 - 8	16.9 - 9.7	21.2 - 12.2	26.7 - 15.4
Ignition transformer	V1 - V2	230 V - 1 x 8 kV			
	I1 - I2	1 A - 20 mA			
Control box	type	RMG88.62 C2/M - LFL1.333 - LGK16.333A27			
Motor protection level	IP	54			
Operation		Intermittent (at least one stop every 24 h) Continuous			
<b>EMISSIONS</b>					
Sound pressure	dB (A)	78	80	82,5	85
Sound power	W	-	-	-	-
CO emission	mg/kWh	< 10			
NO <sub>x</sub> emission	mg/kWh	< 80			
<b>APPROVAL</b>					
Directive		2006/42 - 2009/142 - 2004/108 - 2006/95 EC			
Conforming to		EN 676			
Class of emission		3			
Certification		CE 0085 - In progress			

#### Reference conditions:

Temperature: 20°C - Pressure: 1013,5 mbar - Altitude: 0 m a.s.l. - Noise measured at a distance of 1 meter.

Since the Company is constantly engaged in the production improvement, the aesthetic and dimensional features, the technical data, the equipment and the accessories can be changed. This document contains confidential and proprietary information of RIELLO S.p.A. Unless authorised, this information shall not be divulged, nor duplicated in whole or in part.

**LOW NO<sub>x</sub> FLAME ELECTRONIC CAM VERSIONS**

MODEL		RS 310/E-/EV BLU	RS 410/E-/EV BLU	RS 510/E-/EV BLU	RS 610/E-/EV BLU
Burner operation mode		Modulating			
Modulation ratio at max. output		5 ÷ 1			
Servomotor	type	SQM 33 (FS1 - FS2 version)			
Heat output	kW	400/1200÷3630	500/1500 ÷4450	680/1800÷5250	1000/2200÷6250
	Mcal/h	344/1032÷3122	430/1290÷3827	585/1548÷4515	860/1892÷5375
Gas pressure at max. output (G20-G25)	mbar	50.1/74.7	53.1/79.2	59.7/89.1	77.6/115.8
Working temperature	°C min./max.	0/50			
Fan	type	Forward curve blades			
<b>ELECTRICAL DATA</b>					
Start up	Type	Direct (/E) - Inverter (/EV)			
Electrical supply	Ph/ V/Hz	3N ~ 230 - 400V ±10% 50 Hz			
Total electrical power	kW Max	9.1	10.8	-	-
	kW	7.5	9.2	-	-
Motor electrical power	A	23.9 - 13.8	29.3 - 16.9	-	-
	Type	Star - Delta (/E)		Star - Delta (/E) - Inverter (/EV)	
Electrical supply	Ph/Hz/V	3N ~ 400 - 690V ±10% 50 Hz			
Total electrical power	kW Max	9.1	10.8	14	17
	kW	7.5	9.2	12	15
Motor electrical power	A	13.8 - 8	16.9 - 9.7	21.2 - 12.2	26.7 - 15.4
	V1 - V2	230 V - 1 x 8 kV			
Ignition transformer	I1 - I2	1 A - 20 mA			
	Control box	type	REC27 - REC37		
Motor protection level	IP	54			
Operation		Intermittent (at least one stop every 24 h) Continuous			
<b>EMISSIONS</b>					
Sound pressure	dB (A)	78	80	82,5	85
Sound power	W	-	-	-	-
CO emission	mg/kWh	< 10			
NO <sub>x</sub> emission	mg/kWh	< 80			
<b>APPROVAL</b>					
Directive		2006/42 - 2009/142 - 2004/108 - 2006/95 EC			
Conforming to		EN 676			
Class of emission		3			
Certification		CE 0085 - In progress			

**Reference conditions:**

Temperature: 20°C - Pressure: 1013,5 mbar - Altitude: 0 m a.s.l. - Noise measured at a distance of 1 meter.

Since the Company is constantly engaged in the production improvement, the aesthetic and dimensional features, the technical data, the equipment and the accessories can be changed. This document contains confidential and proprietary information of RIELLO S.p.A. Unless authorised, this information shall not be divulged, nor duplicated in whole or in part.

## YELLOW FLAME MECHANICAL CAM VERSIONS

MODEL		RS 310/M MZ	RS 410/M MZ	RS 510/M MZ	RS 610/M MZ
Burner operation mode		Modulating			
Modulation ratio at max. output		5 ÷ 1			
Servomotor	type	SQM 40			
Heat output	kW	600/1300÷3900	800/2000÷4900	802/2200÷5520	820/2400÷6300
	Mcal/h	516/1118÷3354	688/1720÷4214	689.7/1892÷4747,2	705/2064÷5418
Gas pressure at max. output (G20-G25)	mbar	33.2/49.5	41.6/62	48.9/73	67/100
Working temperature	°C min./max.	0/50			
Fan	type	Forward curve blades			
<b>ELECTRICAL DATA</b>					
Start up	Type	Direct			-
Electrical supply	Ph/ V/Hz	3N ~ 230 - 400V ±10% 50 Hz			-
Total electrical power	kW Max	9.1	10.8	-	-
Motor electrical power	kW	7.5	9.2	-	-
	A	23.9 - 13.8	29.3 - 16.9	-	-
Start up	Type	Star - Delta			-
Electrical supply	Ph/Hz/V	3N ~ 400 - 690V ±10% 50 Hz			-
Total electrical power	kW Max	9.1	10.8	14	17
Motor electrical power	kW	7.5	9.2	12	15
	A	13.8 - 8	16.9 - 9.7	21.2 - 12.2	26.7 - 15.4
Ignition transformer	V1 - V2	230 V - 1 x 8 kV			
	I1 - I2	1 A - 20 mA			
Control box	type	RMG88.62 C2/M - LFL1.333 - LGK16.333A27			
Motor protection level	IP	54			
Operation		Intermittent (at least one stop every 24 h) Continuous			
<b>EMISSIONS</b>					
Sound pressure	dB (A)	78	80	82,5	85
Sound power	W	-	-	-	-
CO emission	mg/kWh	< 10			
NOx emission	mg/kWh	< 120			
<b>APPROVAL</b>					
Directive		2006/42 - 2009/142 - 2004/108 - 2006/95 EC			
Conforming to		EN 676			
Class of emission		2			
Certification		CE 0085 - In progress			

## Reference conditions:

Temperature: 20°C - Pressure: 1013,5 mbar - Altitude: 0 m a.s.l. - Noise measured at a distance of 1 meter.

Since the Company is constantly engaged in the production improvement, the aesthetic and dimensional features, the technical data, the equipment and the accessories can be changed. This document contains confidential and proprietary information of RIELLO S.p.A. Unless authorised, this information shall not be divulged, nor duplicated in whole or in part.

**YELLOW FLAME ELECTRONIC CAM VERSIONS**

MODEL		RS 310/E-/EV MZ	RS 410/E-EV MZ	RS 510/E-EV MZ	RS 610/E-EV MZ
Burner operation mode		Modulating			
Modulation ratio at max. output		5 ÷ 1			
Servomotor	type	SQM 33 (FS1 - FS2 version)			
Heat output	kW	600/1300÷3900	800/2000÷4900	802/2200÷5520	820/2400÷6300
	Mcal/h	516/1118÷3354	688/1720÷4214	689.7/1892÷4747,2	705/2064÷5418
Gas pressure at max. output (G20-G25)	mbar	33.2/49.5	41.6/62	48.9/73	67/100
Working temperature	°C min./max.	0/50			
Fan	type	Forward curve blades			
<b>ELECTRICAL DATA</b>					
Start up	Type	Direct (/E) - Inverter (/EV)			
Electrical supply	Ph/ V/Hz	3N ~ 230 - 400V ±10% 50 Hz			
Total electrical power	kW Max	9.1	10.8	-	-
Motor electrical power	kW	7.5	9.2	-	-
	A	23.9 - 13.8	29.3 - 16.9	-	-
Start up	Type	Star - Delta (/E)		Star - Delta (/E) - Inverter (/EV)	
Electrical supply	Ph/Hz/V	3N ~ 400 - 690V ±10% 50 Hz			
Total electrical power	kW Max	9.1	10.8	14	17
Motor electrical power	kW	7.5	9.2	12	15
	A	13.8 - 8	16.9 - 9.7	21.2 - 12.2	26.7 - 15.4
Ignition transformer	V1 - V2	230 V - 1 x 8 kV			
	I1 - I2	1 A - 20 mA			
Control box	type	REC27 - REC37			
Motor protection level	IP	54			
Operation		Intermittent (at least one stop every 24 h) Continuous			
<b>EMISSIONS</b>					
Sound pressure	dB (A)	78	80	82,5	85
Sound power	W	-	-	-	-
CO emission	mg/kWh	< 10			
NOx emission	mg/kWh	< 120			
<b>APPROVAL</b>					
Directive		2006/42 - 2009/142 - 2004/108 - 2006/95 EC			
Conforming to		EN 676			
Class of emission		2			
Certification		CE 0085 - In progress			

**Reference conditions:**

Temperature: 20°C - Pressure: 1013,5 mbar - Altitude: 0 m a.s.l. - Noise measured at a distance of 1 meter.

Since the Company is constantly engaged in the production improvement, the aesthetic and dimensional features, the technical data, the equipment and the accessories can be changed. This document contains confidential and proprietary information of RIELLO S.p.A. Unless authorised, this information shall not be divulged, nor duplicated in whole or in part.

# Firing Rates

RS 310-410-510-610/M - /E - /EV BLU

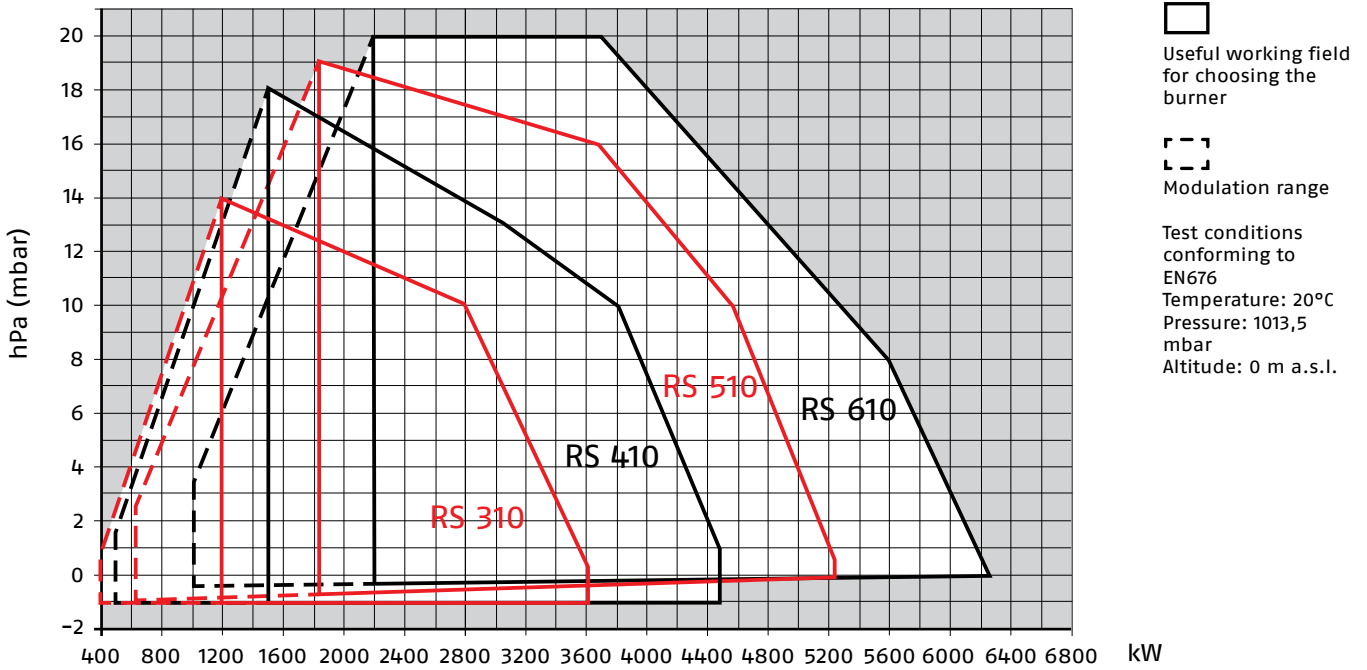

RS 310-410-510-610/M - /E - /EV MZ

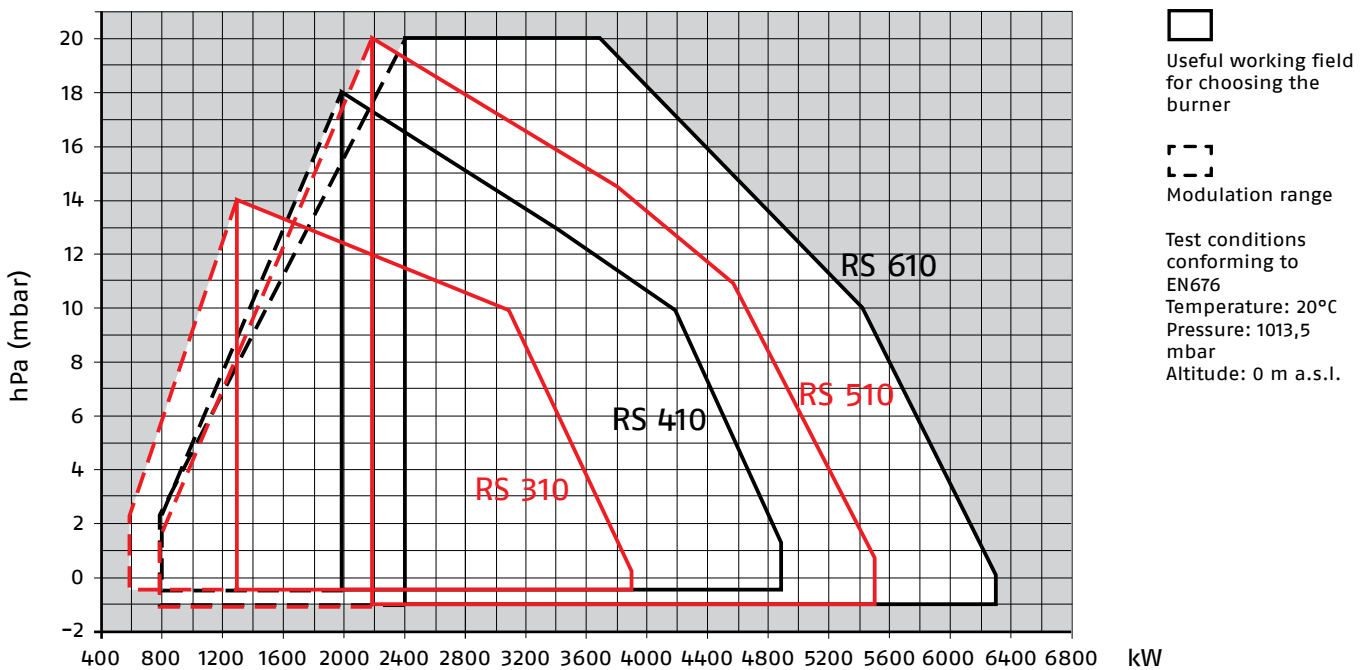



**GAS TRAIN DESIGNATION**

Series: MB

MBC
DMV
DMV12
VGD
CB
CBH
MV
CG

Size:	405	407	410	412	415	420							
		65	120	300	700	1200	-	1900	3100	5000			
	505	507	510	512	-	520	525	5065	5080	50100	50125	50150	
	10	15	20	32	40	-	50	-	65	80	100	125	150
			120	220									

Operation:

/S	only ON-OFF function
/1	stage mode opening
/2	2nd stage mode opening
/P	1st stage mode opening with air/gas proportional regulator

Leak detection control:

-	0
CT	leak detection control device installed on the gas train
CQ	equipped with pressure switch for leak detection control

Joint type:

R	threaded joint
F	standard flange ISO
F1	square flange BS1
F2	square flange BS2
F3	square flange BS3 - BS4

Electrical connection:

T	Terminals - Terminal strip
SD	Domestic plug
SM	Medium voltage plug

Standard output pressure range:

-	without pressure governor
0	with governor and air/gas proportional pressure
2	with governor and output pressure up to 20 mbar
3	with governor and output pressure up to 30 mbar
4	with governor and output pressure up to 40 mbar
5	with governor and output pressure up to 50 mbar
6	with governor and output pressure up to 60 mbar
8	with governor and output pressure up to 80 mbar
15	with governor and output pressure up to 150 mbar

Valve control:

0	shared
2	separate

CB	5065	/1	CT	F	SM	3	0
BASIC DESIGNATION				EXTENDED DESIGNATION			

**GAS TRAINS**

The burners are fitted with a butterfly valve to regulate the fuel, controlled by the main management module of burner through a high precision servomotor.  
 Fuel can be supplied either from the right or left sides, on the basis of the application requirements.  
 A maximum gas pressure switch stops the burner in case of excess pressure in the fuel line.  
 The gas train can be selected to best fit system requirements depending on the fuel output and pressure in the supply line.  
 The gas trains are with or without seal control.

**MB "THREADED"**

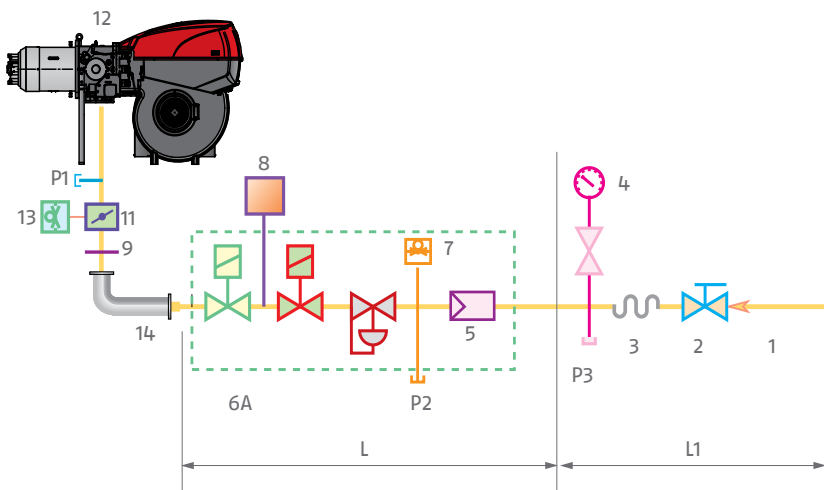

- |    |   |
|----|---|
| 1  | Gas input pipework  |
| 2  | Manual valve  |
| 3  | Anti-vibration joint  |
| 4  | Pressure gauge with pushbutton cock   |
| 5  | Filter  |
| 6A | Includes:   |
|    | - filter  |
|    | - operation valve   |
|    | - safety valve  |
|    | - pressure adjuster   |
| 7  | Minimum gas pressure switch   |
| 8  | Leak detection device, supplied as an accessory or incorporated, based on the gas train code. |
| 9  | Gasket, for "flanged" versions only   |
| 10 | Pressure adjuster   |
| 11 | Gas adjuster butterfly valve  |
| 12 | Burner  |
| 13 | Maximum gas pressure switch   |
| 14 | Gas train-burner adaptor, supplied separately   |
| P1 | Combustion head pressure  |
| P2 | Upstream pressure of valves   |
| P3 | Upstream pressure of the filter   |
| L  | Gas train supplied separately, with the code given in the table.                              |
| L1 | Installer's responsibility  |

**MBC "THREADED"**

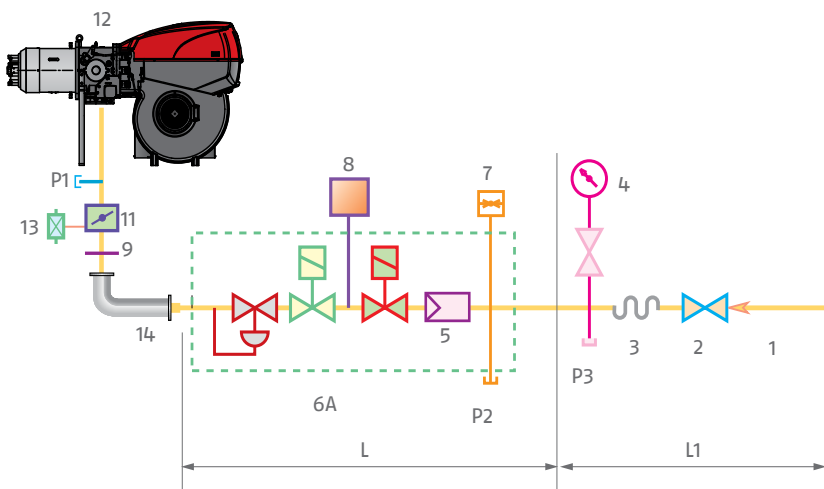

**MBC "FLANGED"**

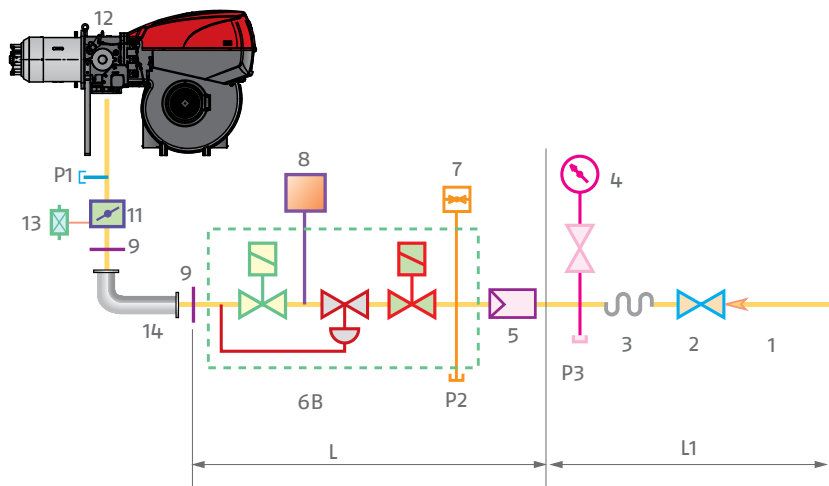

- 1 Gas input pipework
- 2 Manual valve
- 3 Anti-vibration joint
- 4 Pressure gauge with pushbutton cock
- 5 Filter
- 6B Includes:
  - operation valve
  - safety valve
  - pressure adjuster
- 6C Includes:
  - operation valve
  - safety valve
- 6D Includes:
  - operation valve
  - safety valve
- 7 Minimum gas pressure switch
- 8 Leak detection device, supplied as an accessory or incorporated, based on the gas train code.

- 9 Gasket, for "flanged" versions only
- 10 Pressure adjuster
- 11 Gas adjuster butterfly valve
- 12 Burner
- 13 Maximum gas pressure switch
- 14 Gas train-burner adaptor, supplied separately
- P1 Combustion head pressure
- P2 Upstream pressure of valves
- P3 Upstream pressure of the filter
- L Gas train supplied separately, with the code given in the table

**L1** Installer's responsibility

**CB "FLANGED OR THREADED"**

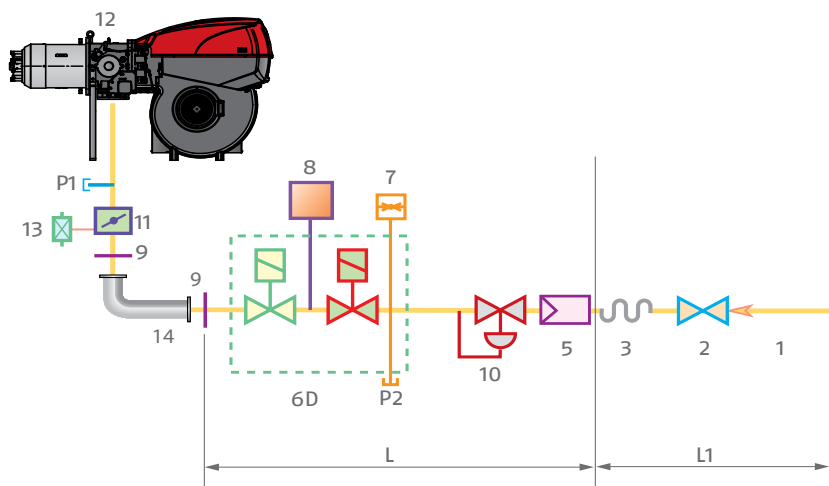

**DMV "FLANGED OR THREADED"**

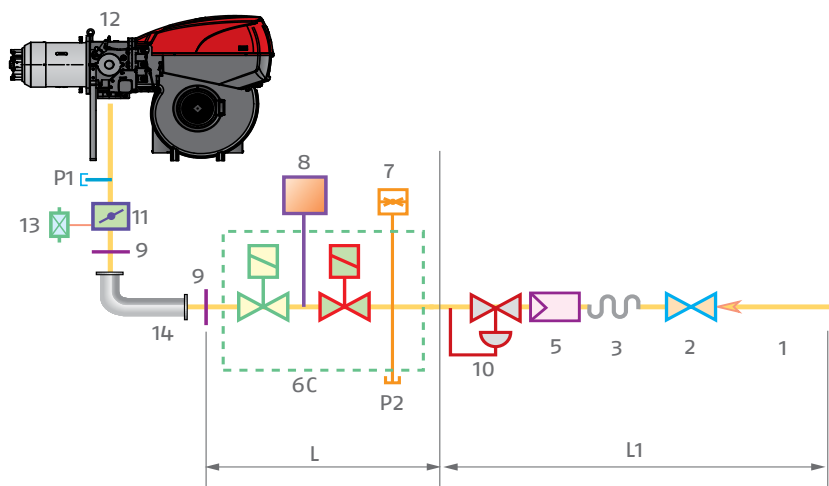

Gas trains are approved by standard EN 676 together with the burner.

The overall dimensions of the gas train depends on how they are constructed. The following table shows the maximum dimensions of the gas trains that can be fitted to RS 650-800-1000-1200/M BLU burners, intake and outlet diameters and seal control if fitted.

The maximum gas pressure of gas train "MULTIBLOC" type is 360 mbar, and that one of gas train "COMPOSED" type is 500 mbar.

"MULTIBLOC" guarantees a range of pressure towards the burner from 4 to 60 mbar. For version DN 65 and DN 80 is from 20 to 40 mbar. For version DN 100 is from 40 to 80 mbar. The range of pressure in the "MULTIBLOC" with flange can be modified choosing the stabiliser spring (see gas train accessory).

The maximum gas pressure of gas train "CB" series is 500 mbar. "CB" gas train guarantees a range of pressure towards the burner from 10 to 30 mbar. The range of pressure can be modified choosing the stabilizer spring (see accessories).

The maximum gas pressure of gas train "DMV" series is 500 mbar. "DMV" gas train is supplied without pressure governor.

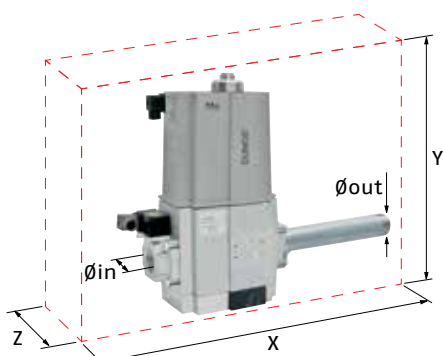

Example of gas train "MULTIBLOC" type without seal control (i.e. MBC 1200)

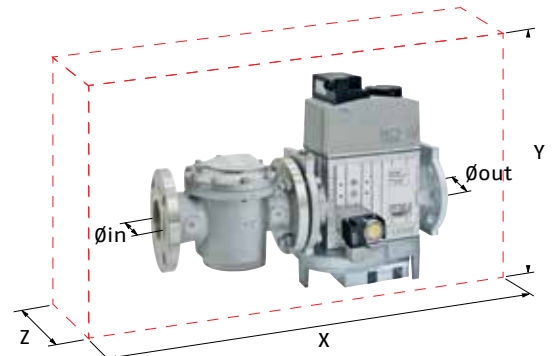

Example of gas train "COMPOSED" type without seal control (i.e. MBC 1900-3100-5000)



Example of gas train "CB" series with seal control

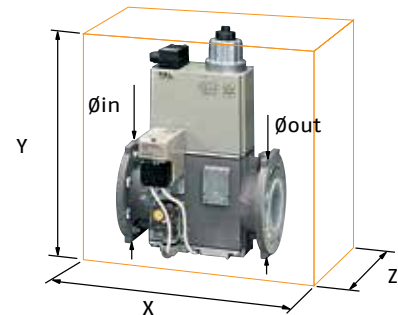

Example of gas train "DMV" series with seal control

**GAS TRAIN**

MODEL	CODE	$\varnothing$ in	$\varnothing$ out	X mm	Y mm	Z mm
MB 415/1 - RT 30	3970180	Rp 1-1/2"	Rp 1-1/2"	523	250	100
MB 415/1 CT RT 30	3970198	Rp 1-1/2"	Rp 1-1/2"	523	250	229
MB 415/1 - RT 52	3970250	Rp 1-1/2"	Rp 1-1/2"	523	250	100
MB 415/1 CT RT 52	3970253	Rp 1-1/2"	Rp 1-1/2"	523	250	229
MB 415/1 RSM 30	3970232	Rp 1-1/2"	Rp 1-1/2"	523	250	100
MB 420/1 RT 30	3970181	Rp 2"	Rp 2"	523	289	100
MB 420/1 CT RT 30	3970182	Rp 2"	Rp 2"	523	289	229
MB 420/1 RT 52	3970257	Rp 2"	Rp 2"	523	289	100
MB 420/1 CT RT 52	3970252	Rp 2"	Rp 2"	523	289	229
MB 420/1 RSM 30	3970233	Rp 2"	Rp 2"	523	289	100
MB 420/1 CT RSM 30	3970234	Rp 2"	Rp 2"	523	289	229

<b>GAS TRAIN</b>						
<b>MODEL</b>	<b>CODE</b>	<b>∅ in</b>	<b>∅ out</b>	<b>X mm</b>	<b>Y mm</b>	<b>Z mm</b>
MBC 1200/1 - RSM 60	3970221	Rp 2"	Rp 2"	528	424	161
MBC 1200/1 CT RSM 60	3970225	Rp 2"	Rp 2"	528	424	290
MBC 1900/1 - FSM 40	3970222	DN 65	DN 65	613	430	237
MBC 1900/1 CT FSM 40	3970226	DN 65	DN 65	613	430	298
MBC 3100/1 - FSM 40	3970223	DN 80	DN 80	633	500	240
MBC 3100/1 CT FSM 40	3970227	DN 80	DN 80	633	500	319
MBC 5000/1 - FSM 80	3970224	DN 100	DN 100	733	576	280
MBC 5000/1 CT FSM 80	3970228	DN 100	DN 100	733	576	348

<b>GAS TRAIN</b>						
<b>MODEL</b>	<b>CODE</b>	<b>∅ in</b>	<b>∅ out</b>	<b>X mm</b>	<b>Y mm</b>	<b>Z mm</b>
CB 512/1 - RSM 30	3970145	Rp 1-1/2"	Rp 1-1/2"	891	261	245
CB 512/1 - CT RSM 30	20045589	Rp 1-1/2"	Rp 1-1/2"	891	261	245
CB 520/1 - RSM 30	3970146	Rp 2"	Rp 2"	986	328	255
CB 520/1 - CT RSM 30	3970160	Rp 2"	Rp 2"	986	328	255
CB 525/1 - RSM 30	20044659	Rp 2"	Rp 2"	1025	356	285
CB 525/1 - CT RSM 30	20044660	Rp 2"	Rp 2"	1025	356	285
CB 5065/1 - FSM 30	3970147	DN 65	DN 65	906	356	285
CB 5065/1 CT FSM 30	3970161	DN 65	DN 65	906	356	285
CB 5080/1 - FSM 30	3970148	DN 80	DN 80	934	416	285
CB 5080/1 CT FSM 30	3970162	DN 80	DN 80	934	416	285
CB 50100/1 - FSM 30	3970149	DN 100	DN 100	1054	501	350
CB 50100/1 CT FSM 30	3970163	DN 100	DN 100	1054	501	350
CB 50125/1 - FSM 30	20015871	DN 125	DN 125	1164	780	400
CB 50125/1 CT FSM 30	3970196	DN 125	DN 125	1164	780	400

<b>GAS TRAIN</b>						
<b>MODEL</b>	<b>CODE</b>	<b>∅ in</b>	<b>∅ out</b>	<b>X mm</b>	<b>Y mm</b>	<b>Z mm</b>
DMV 512/1 - RSM - 0	20043035	Rp 1-1/2"	Rp 1-1/2"	490	292	245
DMV 512/1 -CT RSM - 0	20043036	Rp 1-1/2"	Rp 1-1/2"	490	292	245
DMV 512/1 - CQ RSM - 2	20043037	Rp 1-1/2"	Rp 1-1/2"	490	292	245
DMV 520/1 - RSM - 0	20043038	Rp 2"	Rp 2"	490	292	255
DMV 520/1 CT RSM - 0	20043039	Rp 2"	Rp 2"	490	292	255
DMV 520/1 CQ RSM - 2	20043040	Rp 2"	Rp 2"	490	292	255
DMV 525/1 - RSM - 0	20043053	Rp 2"	Rp 2"	530	338	270
DMV 525/1 CT RSM - 0	20043054	Rp 2"	Rp 2"	530	338	270
DMV 525/1 CQ RSM - 2	20043055	Rp 2"	Rp 2"	530	338	270
DMV 5065/1 - FSM - 0	20043041	DN 65	DN 65	290	338	270
DMV 5065/1 CT FSM - 0	20043042	DN 65	DN 65	290	338	270
DMV 5065/1 CQ FSM - 2	20043043	DN 65	DN 65	290	338	270
DMV 5080/1 - FSM - 0	20043044	DN 80	DN 80	310	397	290
DMV 5080/1 CT FSM - 0	20043045	DN 80	DN 80	310	397	290
DMV 5080/1 CQ FSM - 2	20043046	DN 80	DN 80	310	397	290
DMV 50100/1 - FSM - 0	20043047	DN 100	DN 100	350	449	307
DMV 50100/1 CT FSM - 0	20043048	DN 100	DN 100	350	449	307
DMV 50100/1 CQ FSM - 2	20043049	DN 100	DN 100	350	449	307
DMV 50125/1 - FSM - 0	20043050	DN 125	DN 125	400	554	333
DMV 50125/1 CT FSM - 0	20043051	DN 125	DN 125	400	554	333
DMV 50125/1 CQ FSM - 2	20043052	DN 125	DN 125	400	554	333

# Pressure Drop Diagram

The diagrams indicate the minimum pressure drop of the burners with the various gas trains that can be matched with them; at the value of these pressure drop add the combustion chamber pressure. The value thus calculated represents the minimum required input pressure to the gas train.

The minimum input gas pressure required is 15 mbar while burner operating. In particular, the pressure difference between gas train upstream and downstream has to remain always over pressure drop values indicated below.

## RS 310/M - /E - EV BLU (NATURAL GAS)

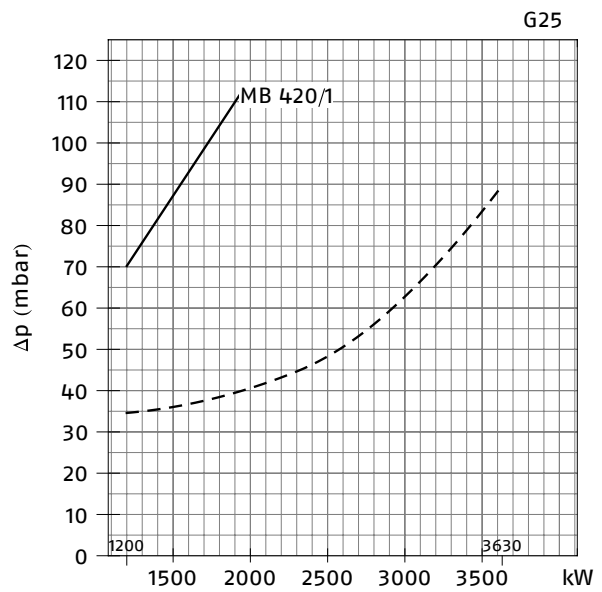
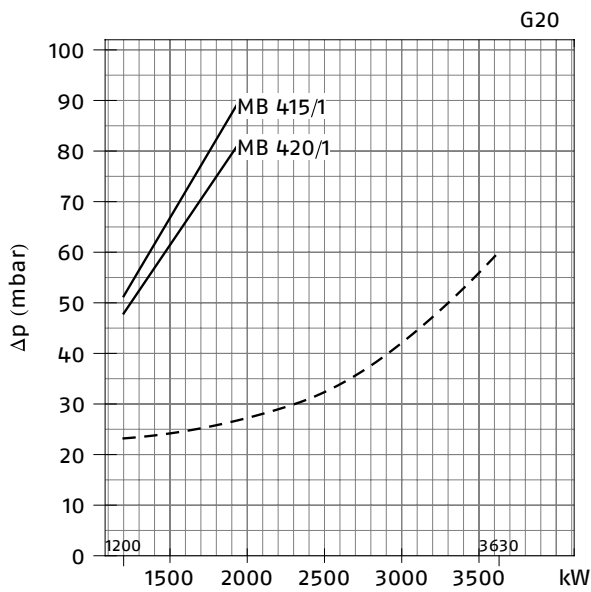

## RS 310/M - /E - EV BLU (NATURAL GAS)

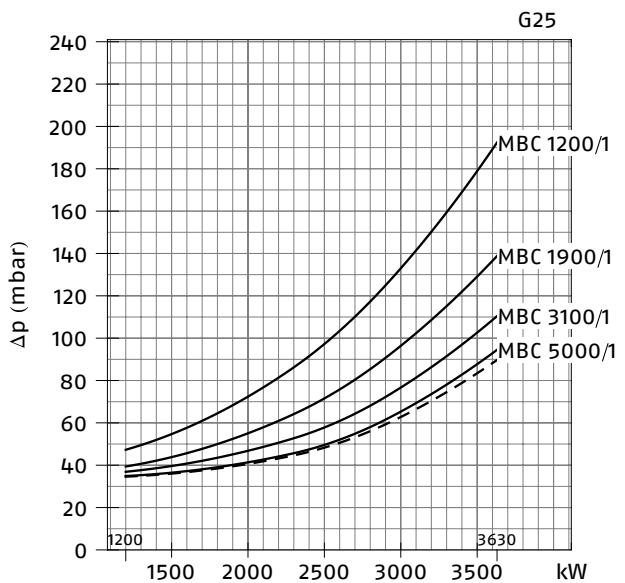
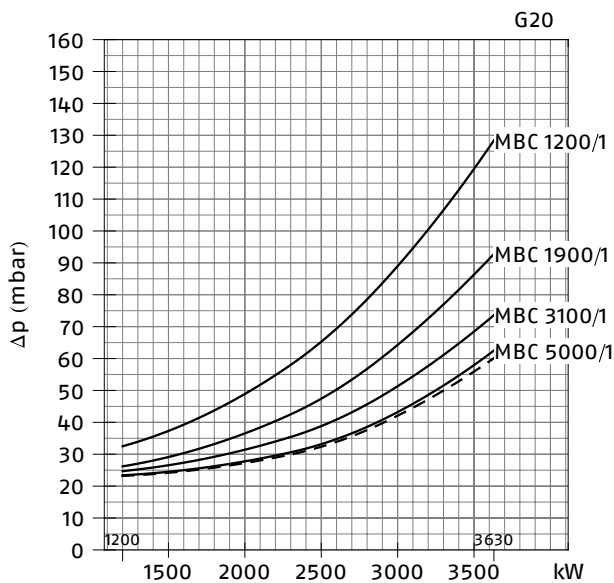

- Combustion head + gas butterfly valve + gas train
- - - Combustion head + gas butterfly valve

**RS 310/M - /E - EV BLU (NATURAL GAS)**

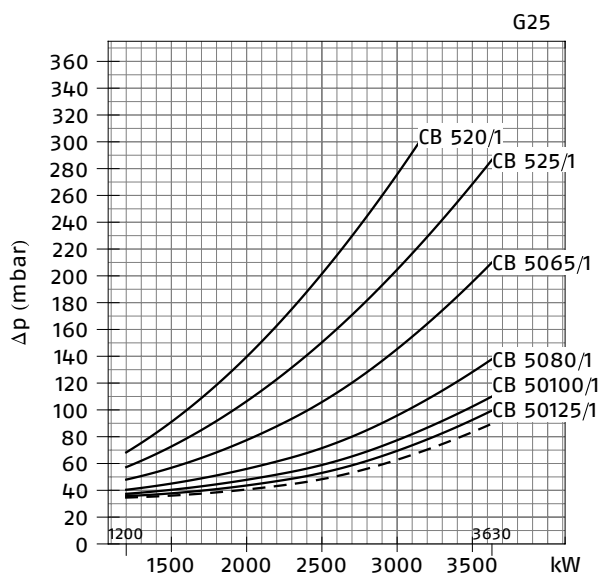
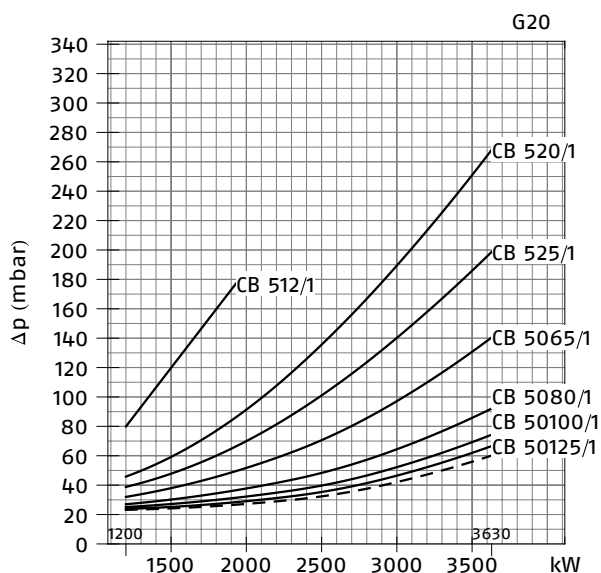

**RS 310/M - /E - EV BLU (NATURAL GAS)**

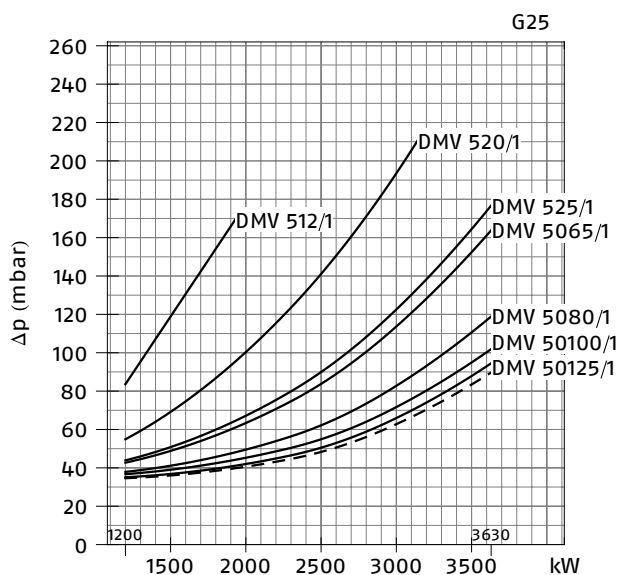
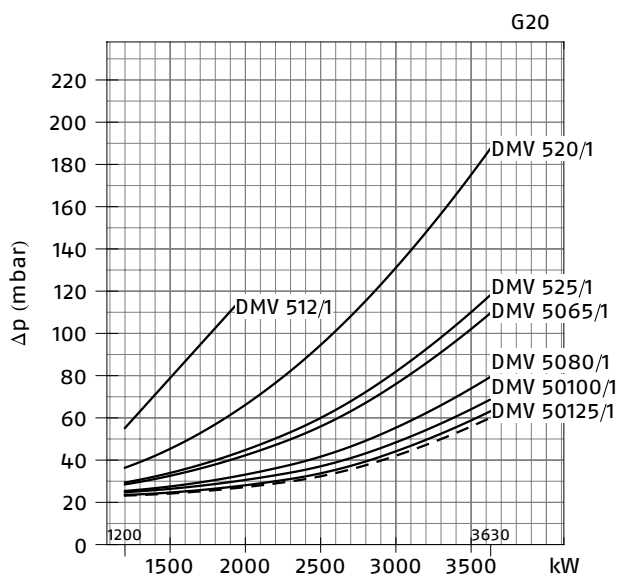

— Combustion head + gas butterfly valve + gas train  
 - - - Combustion head + gas butterfly valve



RS 410/M - /E - /EV BLU (NATURAL GAS)

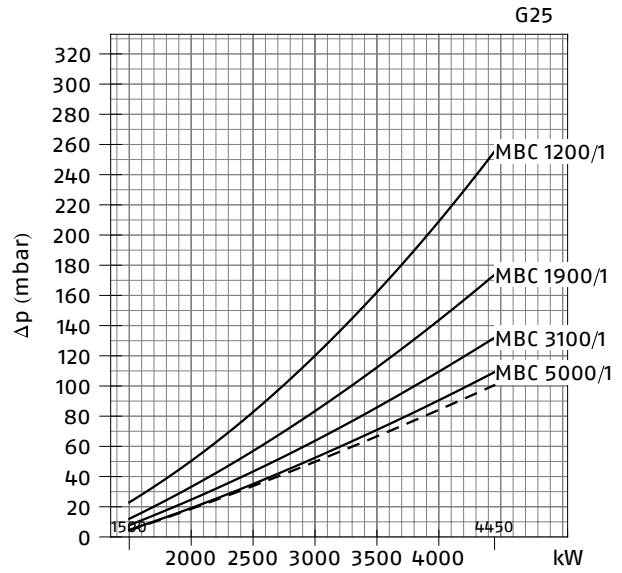
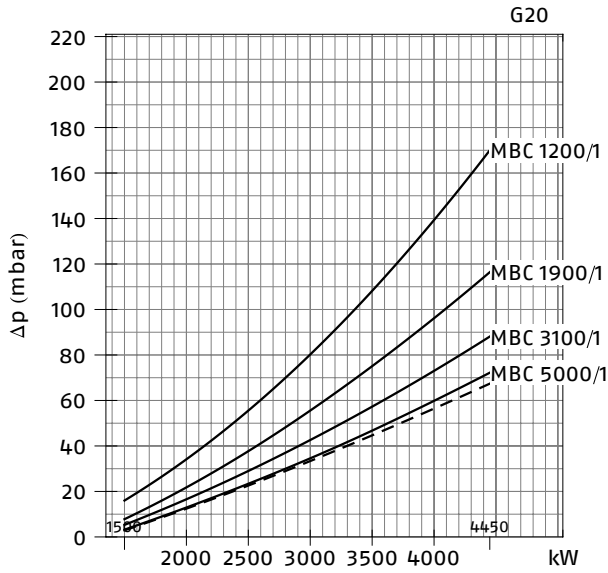

RS 410/M - /E - /EV BLU (NATURAL GAS)

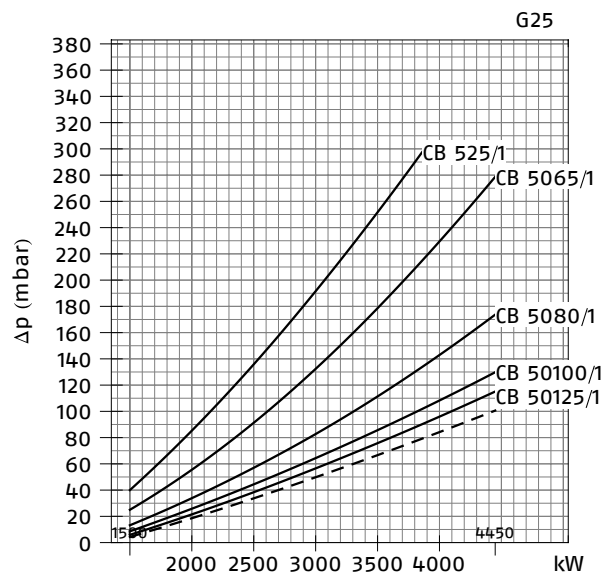
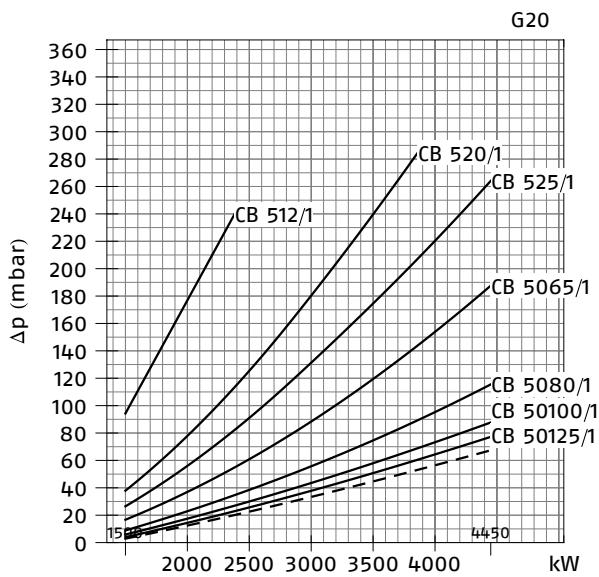

— Combustion head + gas butterfly valve + gas train  
 - - - Combustion head + gas butterfly valve



**RS 410/M - /E - /EV BLU (NATURAL GAS)**

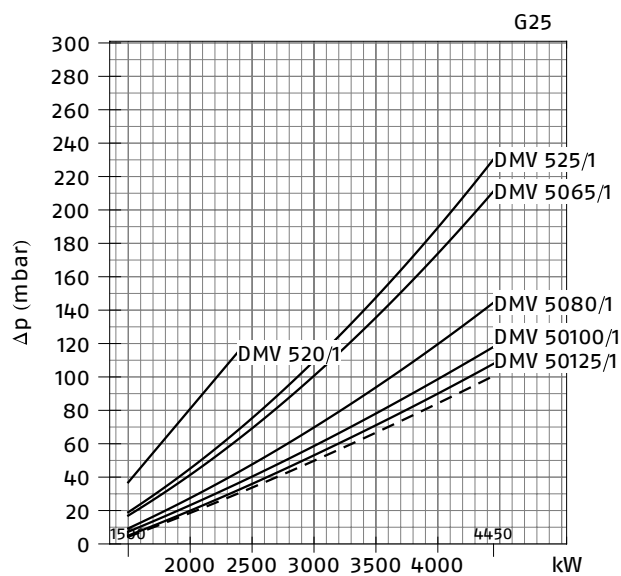
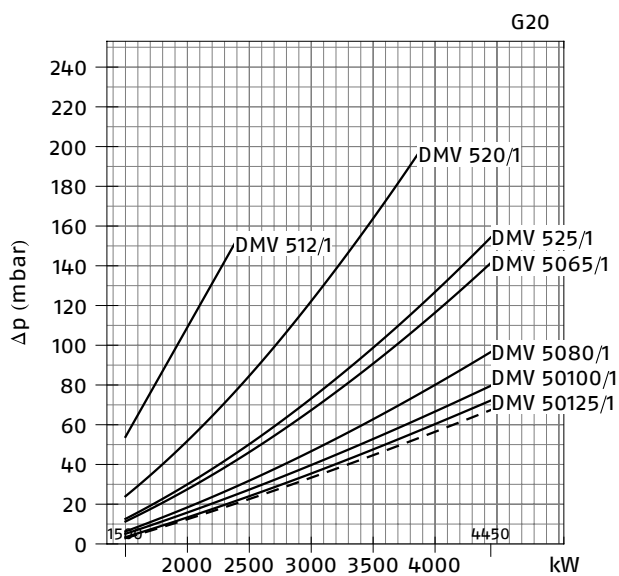

**RS 510/M - /E - EV BLU (NATURAL GAS)**

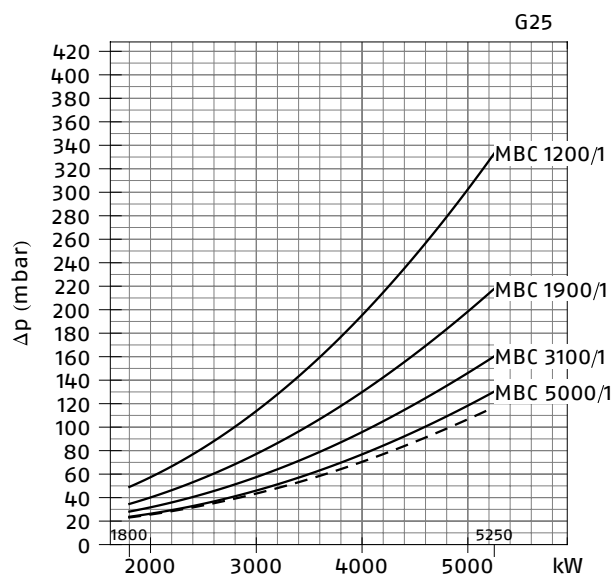
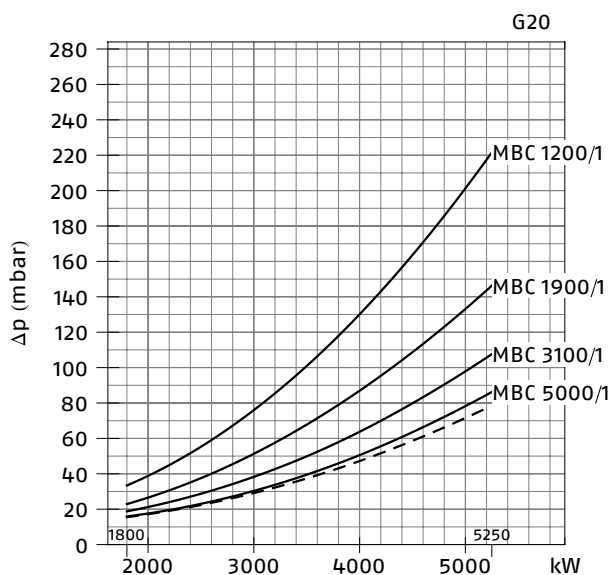

Combustion head + gas butterfly valve + gas train  
 Combustion head + gas butterfly valve

RS 510/M - /E - EV BLU (NATURAL GAS)

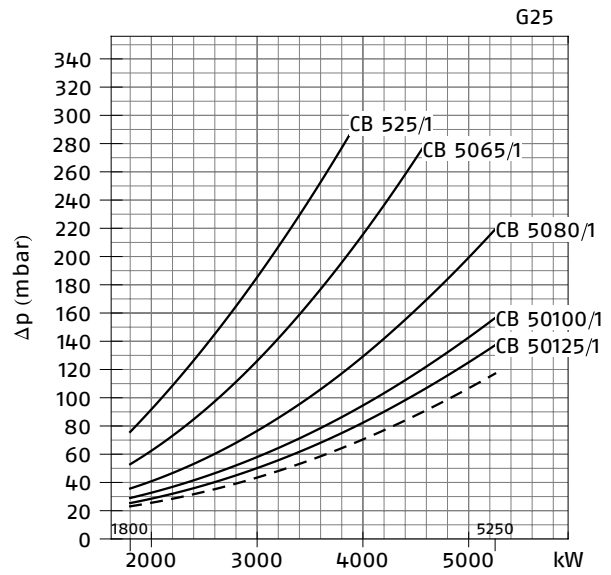
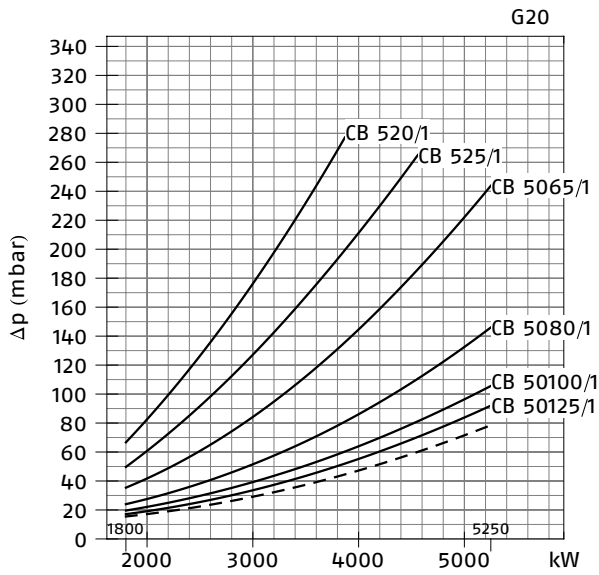

RS 510/M - /E - EV BLU (NATURAL GAS)

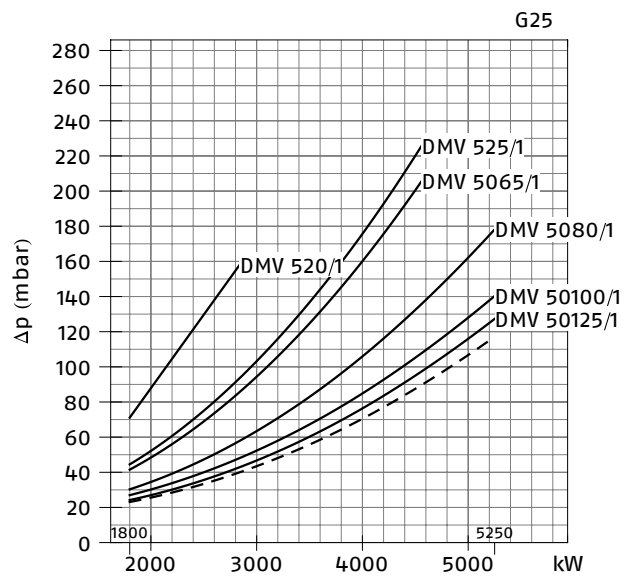
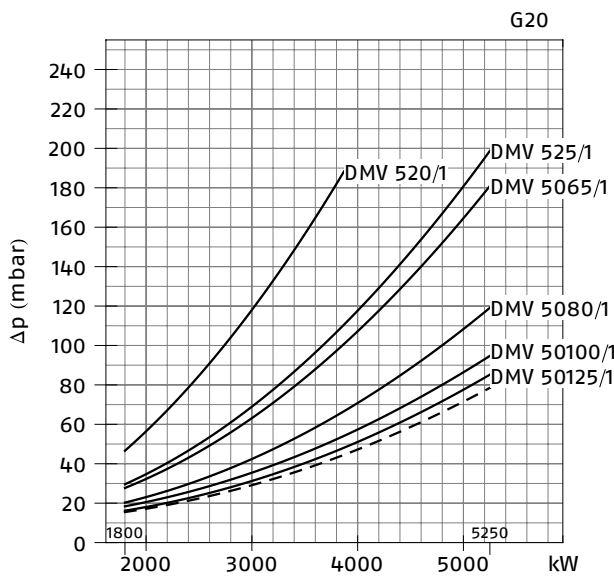

— Combustion head + gas butterfly valve + gas train  
 - - - Combustion head + gas butterfly valve

**RS 610/M - /E - EV BLU (NATURAL GAS)**

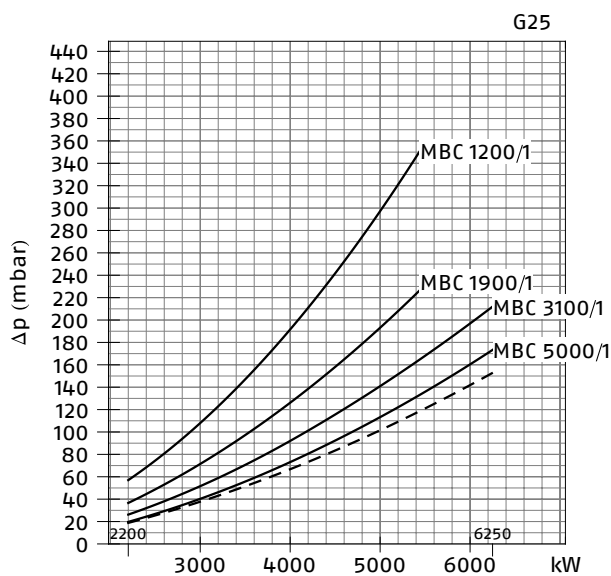
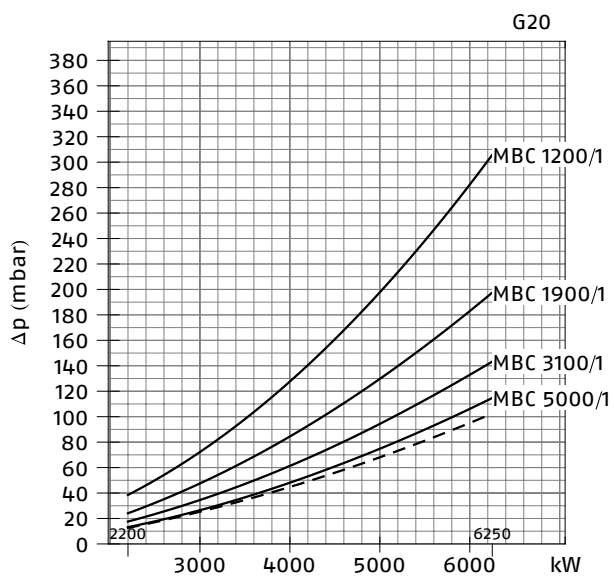

**RS 610/M - /E - EV BLU (NATURAL GAS)**

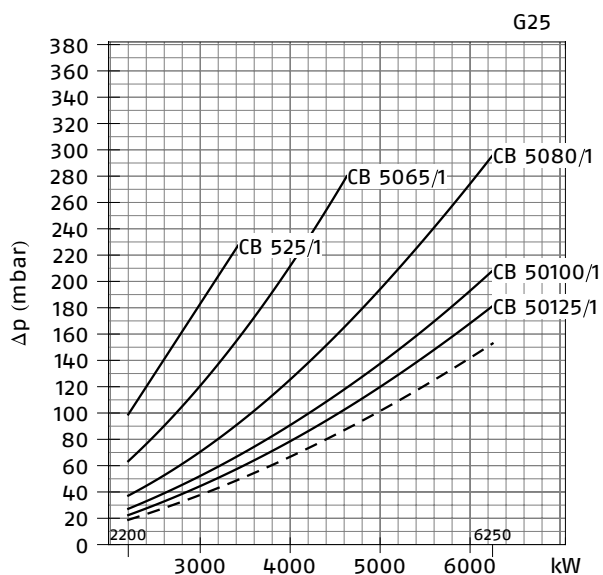
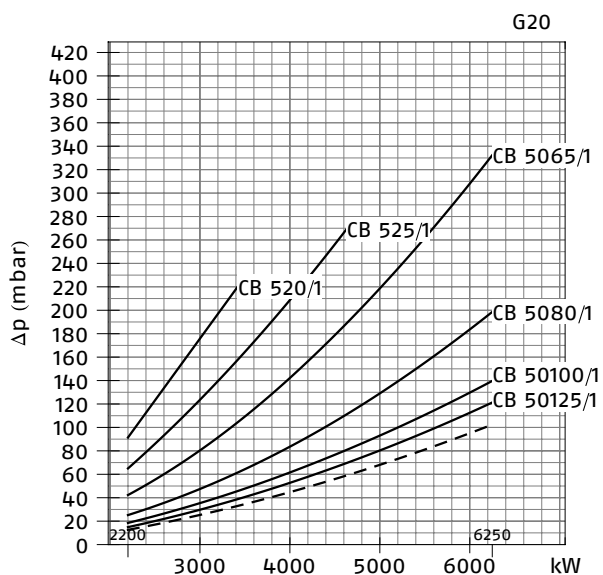

— Combustion head + gas butterfly valve + gas train  
 - - - Combustion head + gas butterfly valve

RS 610/M - /E - EV BLU (NATURAL GAS)

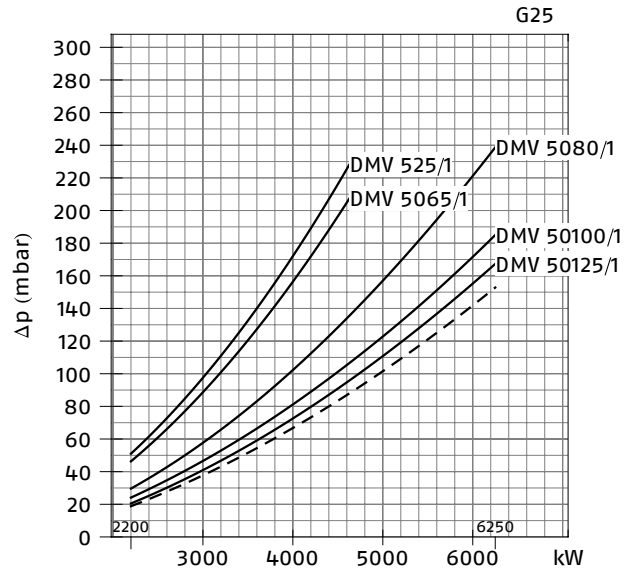
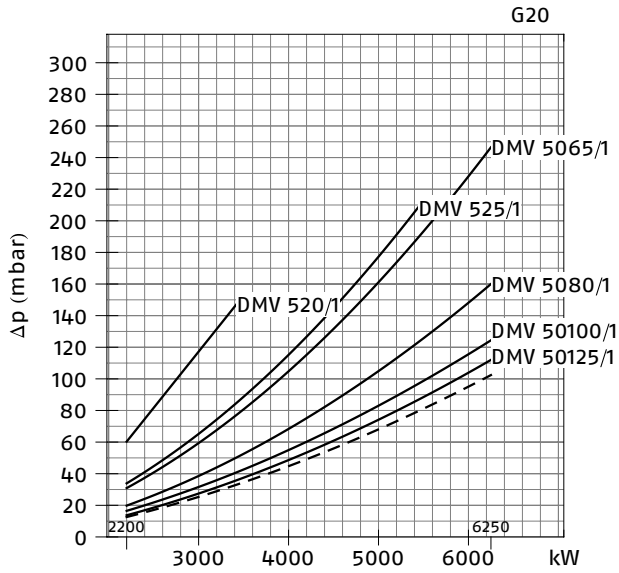

— Combustion head + gas butterfly valve + gas train  
 - - - Combustion head + gas butterfly valve

**RS 310/M - /E - /EV MZ (NATURAL GAS)**

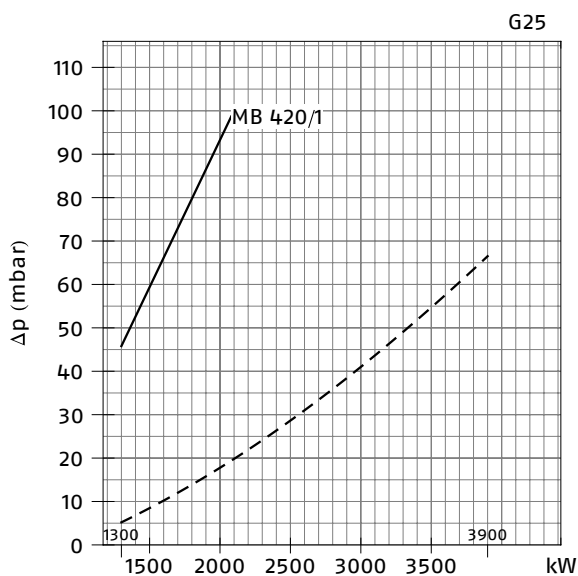
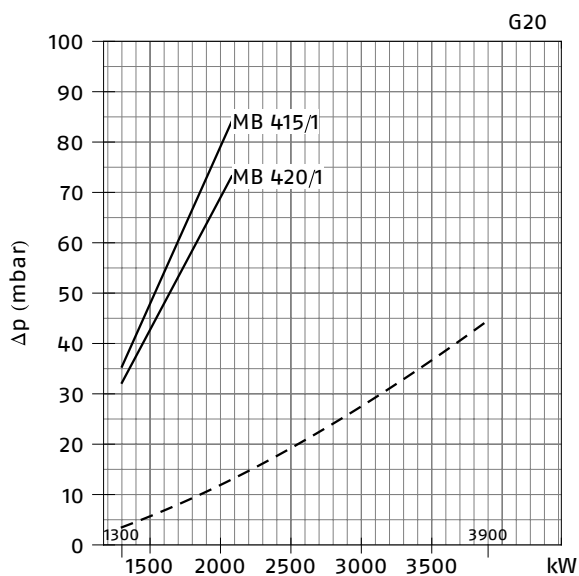

**RS 310/M - /E - /EV MZ (NATURAL GAS)**

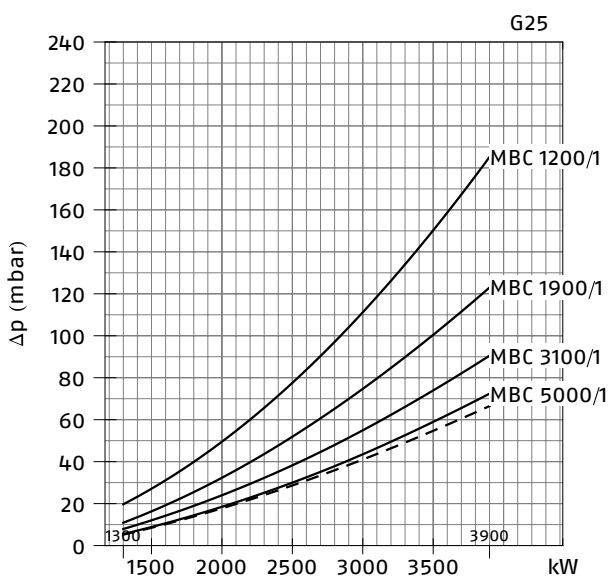
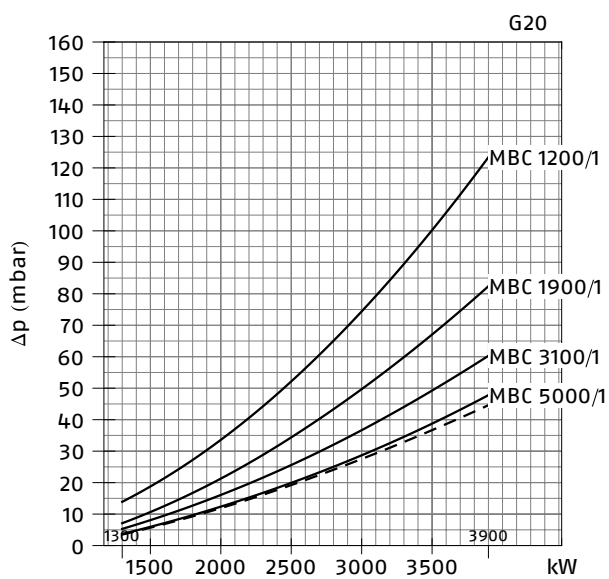

- Combustion head + gas butterfly valve + gas train
- - - Combustion head + gas butterfly valve

RS 310/M - /E - /EV MZ (NATURAL GAS)

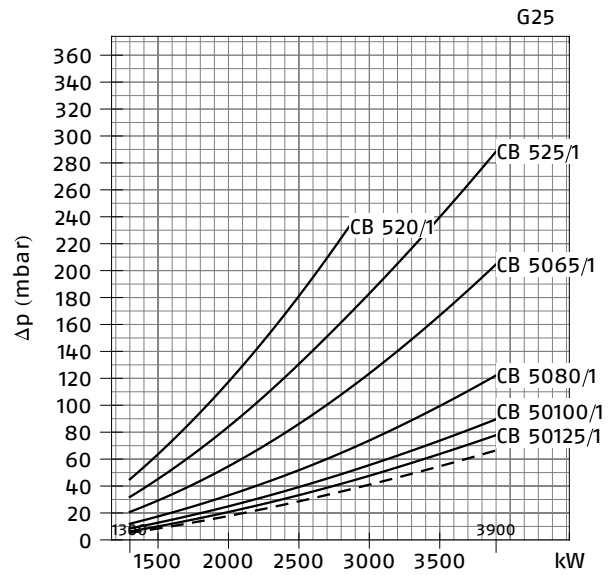
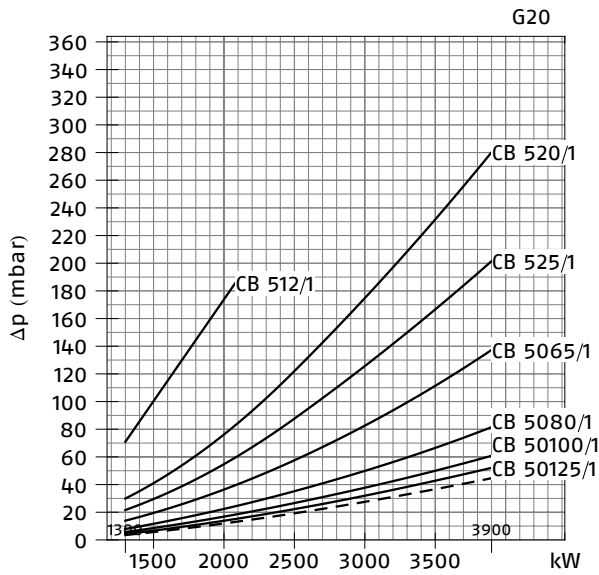

RS 310/M - /E - /EV MZ (NATURAL GAS)

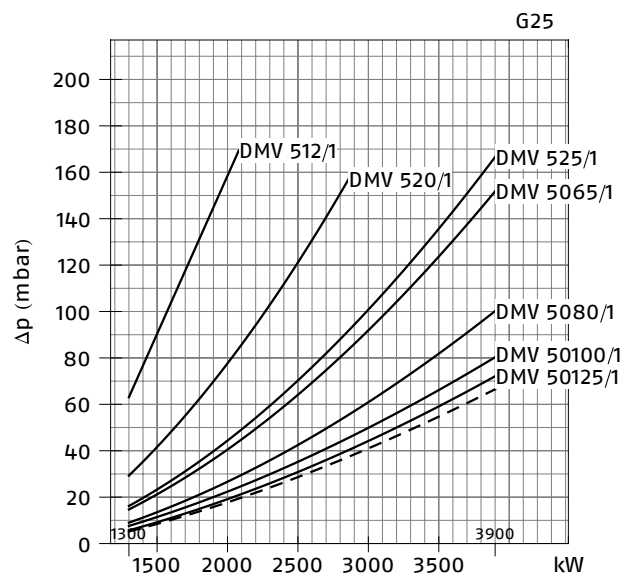
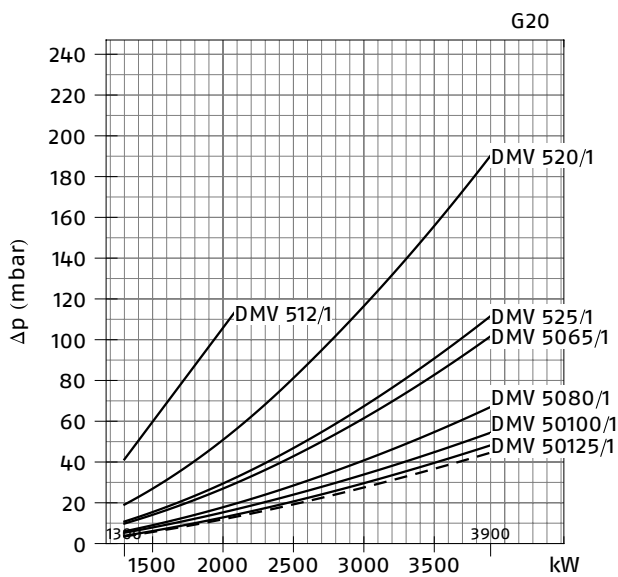

— Combustion head + gas butterfly valve + gas train  
 - - - Combustion head + gas butterfly valve

**RS 410/M - /E - /EV MZ (NATURAL GAS)**

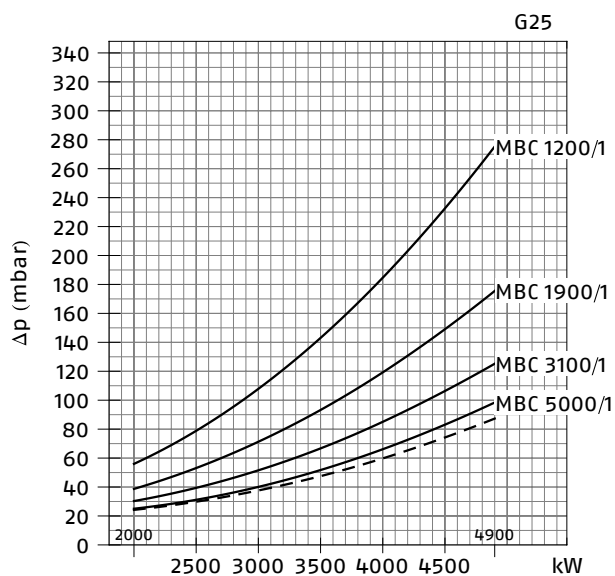
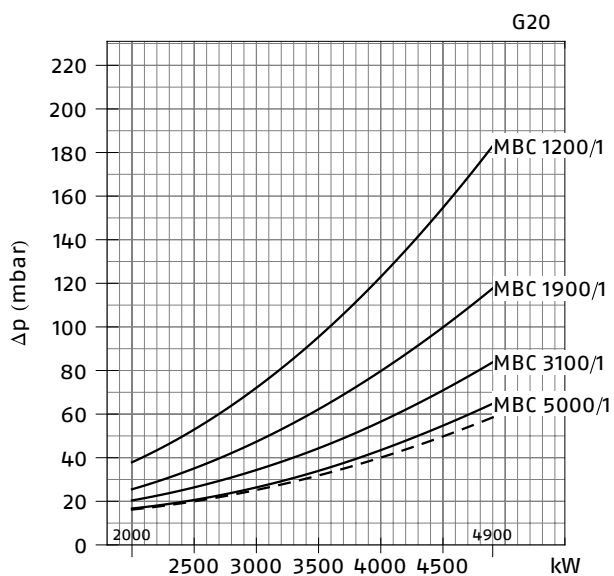

**RS 410/M - /E - /EV MZ (NATURAL GAS)**

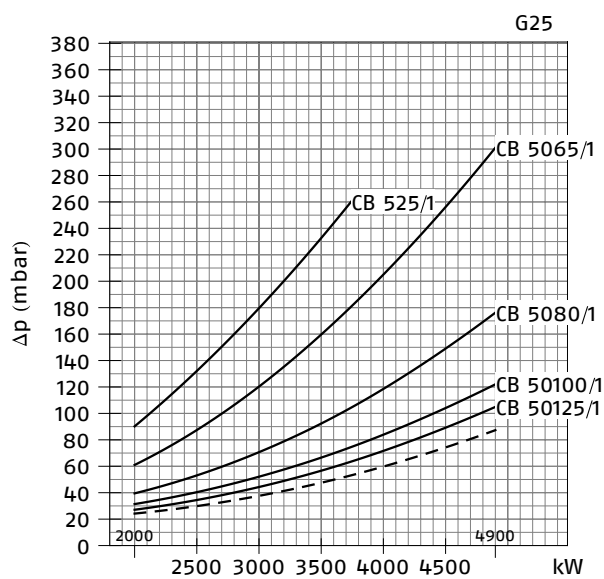
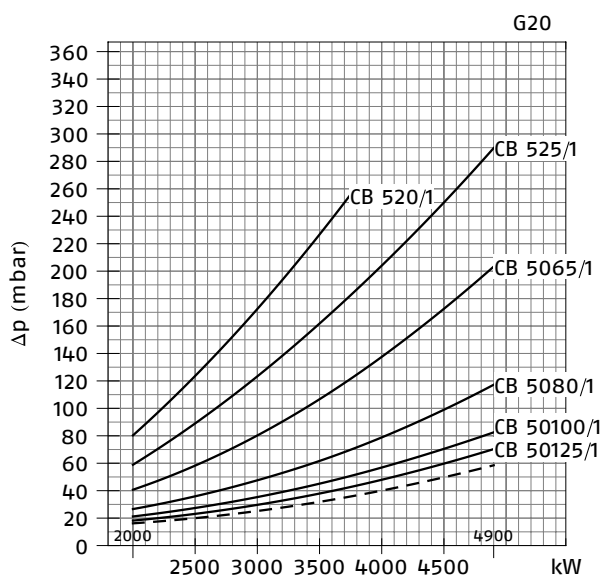

— Combustion head + gas butterfly valve + gas train  
 - - - Combustion head + gas butterfly valve

RS 410/M - /E - /EV MZ (NATURAL GAS)

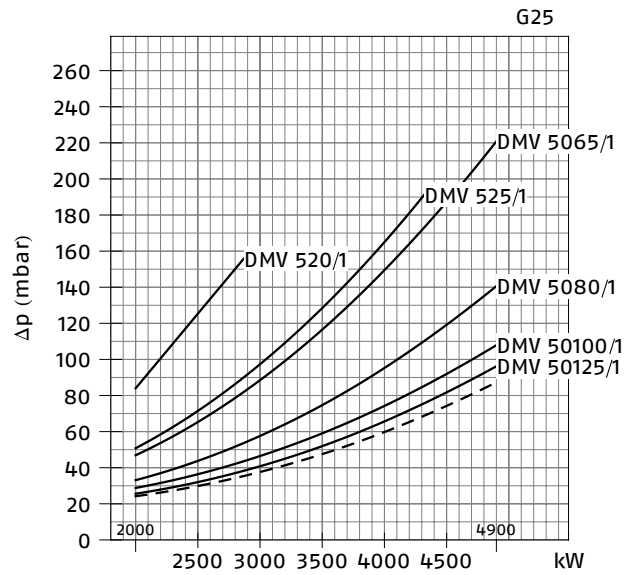
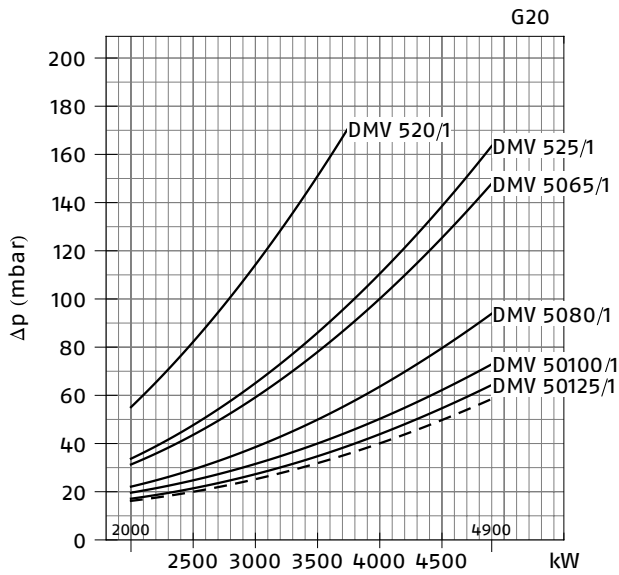

RS 510/M - /E - /EV MZ (NATURAL GAS)

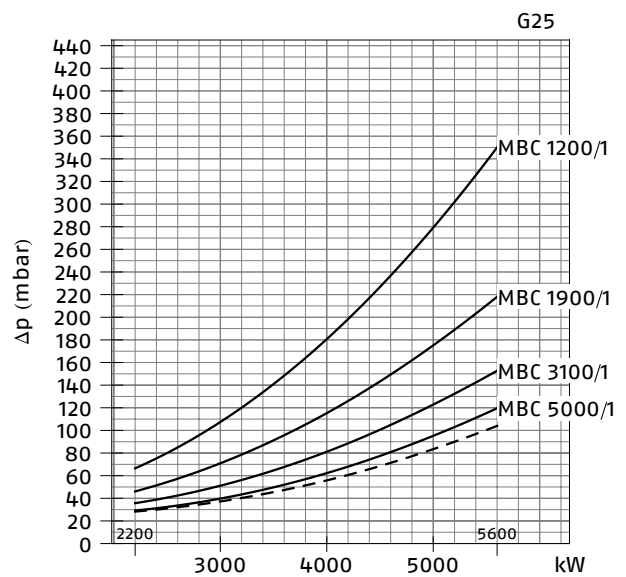
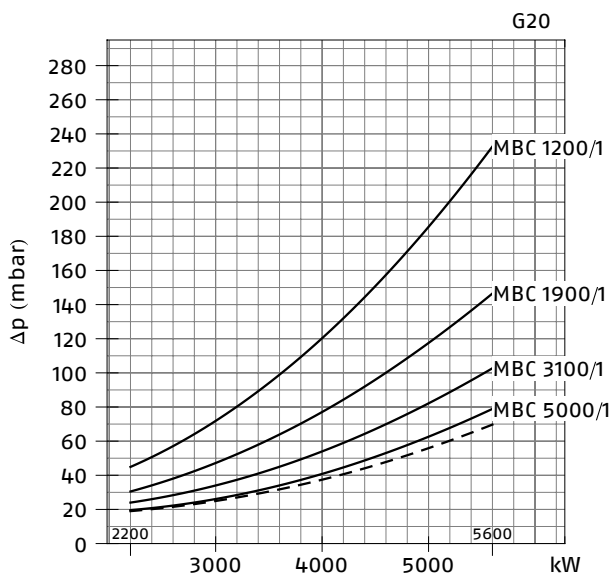

— Combustion head + gas butterfly valve + gas train  
 - - - Combustion head + gas butterfly valve



**RS 510/M - /E - /EV MZ (NATURAL GAS)**

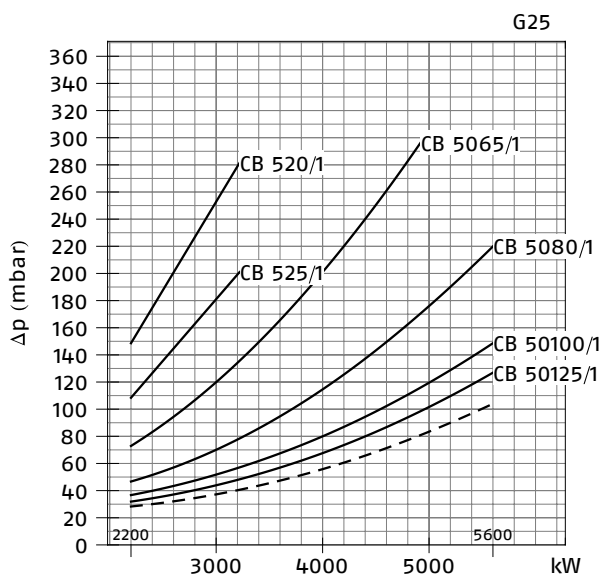
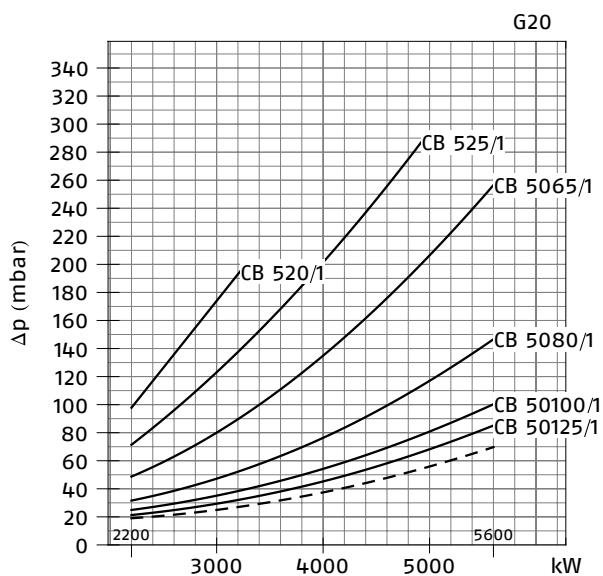

**RS 510/M - /E - /EV MZ (NATURAL GAS)**

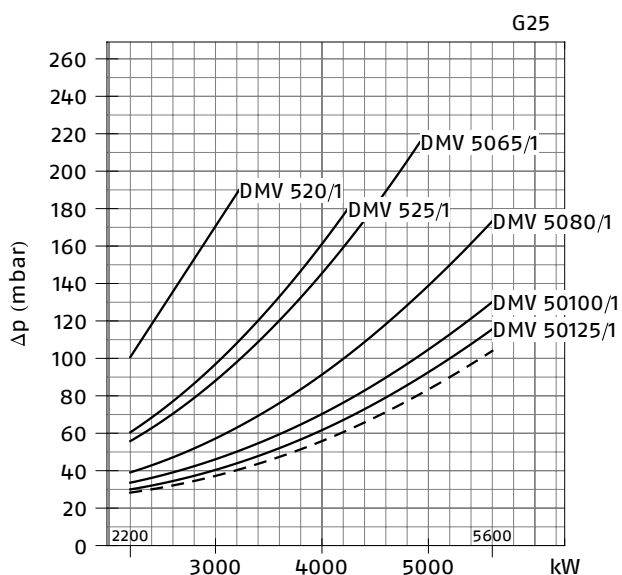
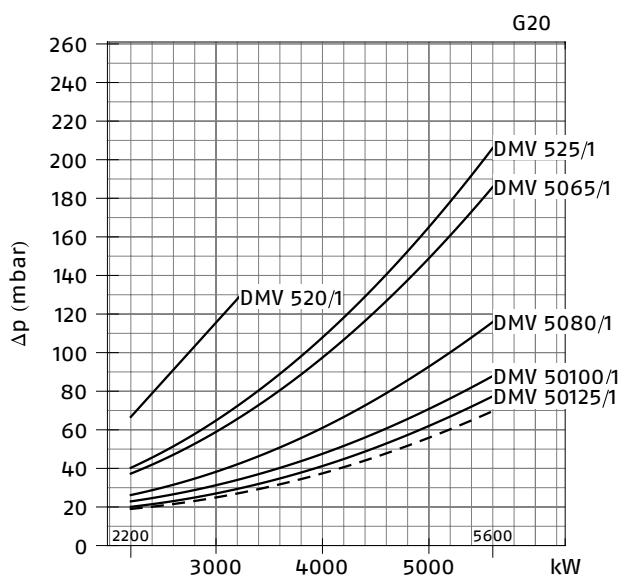

- Combustion head + gas butterfly valve + gas train
- - - Combustion head + gas butterfly valve

RS 610/M - /E - /EV MZ (NATURAL GAS)

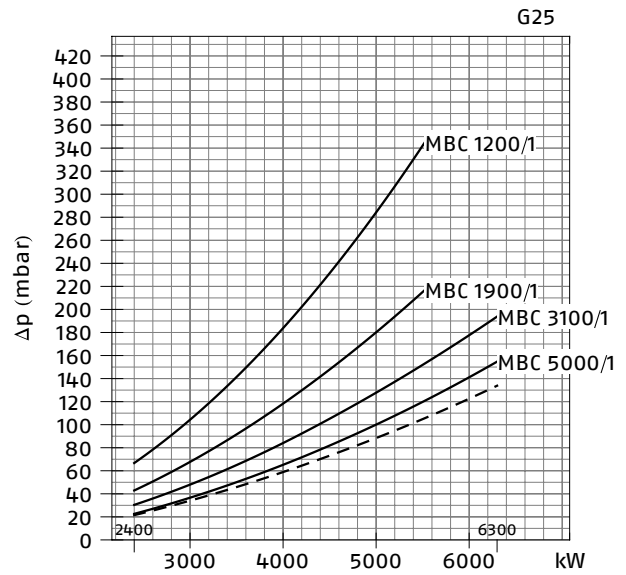
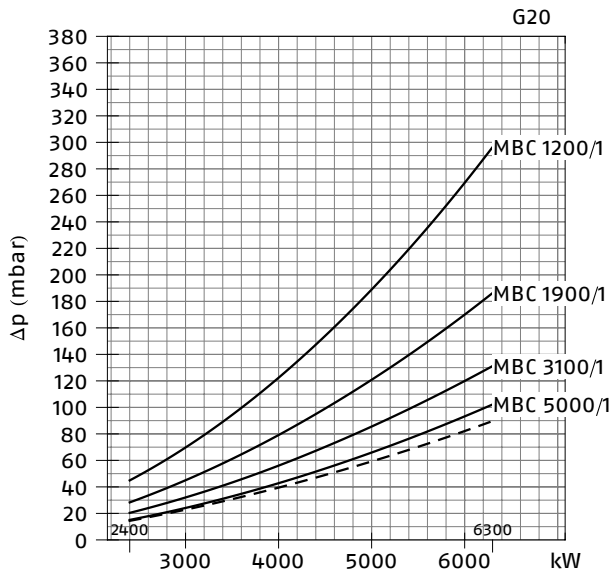

RS 610/M - /E - /EV MZ (NATURAL GAS)

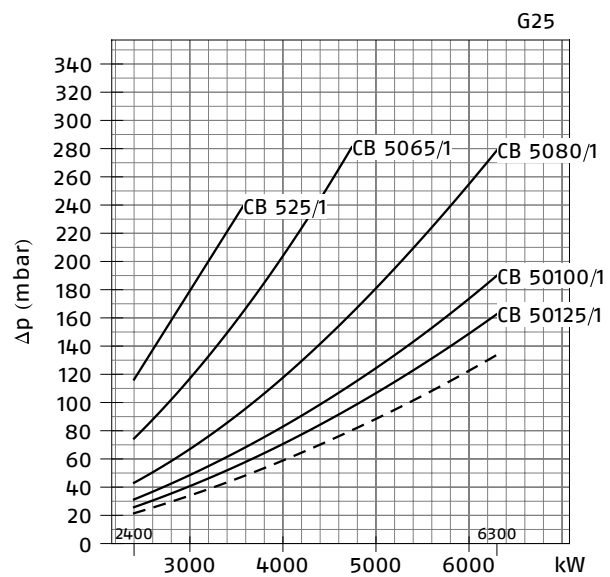
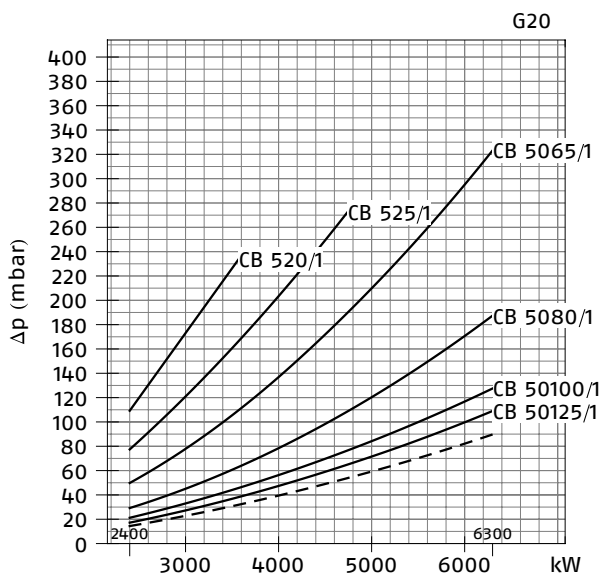

— Combustion head + gas butterfly valve + gas train  
 - - - Combustion head + gas butterfly valve

**RS 610/M - /E - /EV MZ (NATURAL GAS)**

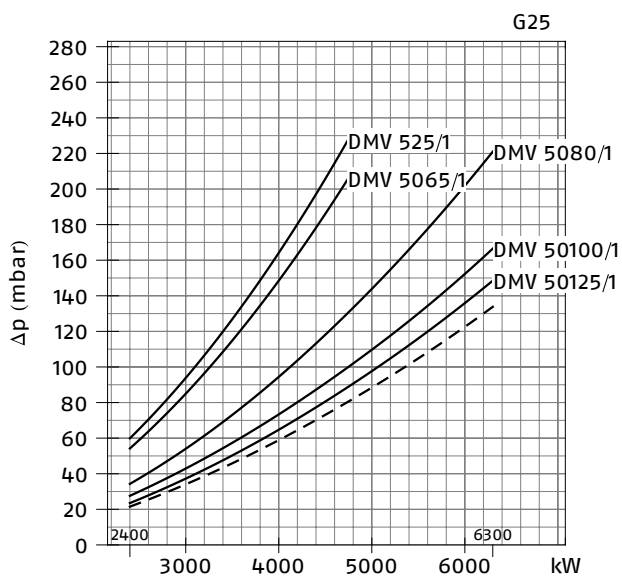
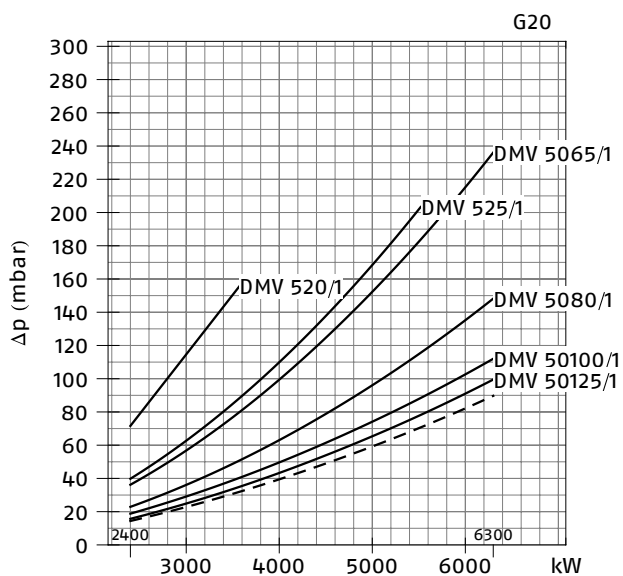

— Combustion head + gas butterfly valve + gas train  
 - - - Combustion head + gas butterfly valve

GAS TRAIN			VPS KIT	CQ KIT	ADAPTER			
CODE	MODEL	◆	CODE	CODE	CODE			
					RS 310	RS 410	RS 510	RS 610
3970180	MB 415/1 - RT 30	-	3010223	-	3000826 + 20064220	●	●	●
3970198	MB 415/1 CT RT 30	CT	-	-	3000826 + 20064220	●	●	●
3970250	MB 415/1 - RT 52	-	3010223	3010344	3000826 + 20064220	●	●	●
3970253	MB 415/1 CT RT 52	CT	-	-	3000826 + 20064220	●	●	●
3970232	MB 415/1 - RSM 30	-	3010223	-	3000826 + 20064220	●	●	●
3970181	MB 420/1 - RT 30	-	3010223	-	3000826 + 20042324	●	●	●
3970182	MB 420/1 CT RT 30	CT	-	-	3000826 + 20042324	●	●	●
3970257	MB 420/1 - RT 52	-	3010223	3010344	3000826 + 20042324	●	●	●
3970252	MB 420/1 CT RT 52	CT	-	-	3000826 + 20042324	●	●	●
3970233	MB 420/1 - RSM 30	-	3010223	-	3000826 + 20042324	●	●	●
3970234	MB 420/1 CT RSM 30	CT	-	-	3000826 + 20042324	●	●	●
3970221	MBC 1200/1 - RSM 60	-	3010367	3010344	3000826 + 20042324			
3970225	MBC 1200/1 CT RSM 60	CT	-	-	3000826 + 20042324			
3970222	MBC 1900/1 - FSM 40	-	3010367	3010344	3010221			
3970226	MBC 1900/1 CT FSM 40	CT	-	-	3010221			
3970223	MBC 3100/1 - FSM 40	-	3010367	3010344	3010222			
3970227	MBC 3100/1 CT FSM 40	CT	-	-	3010222			
3970224	MBC 5000/1 - FSM 80	-	3010367	3010344	3010222 - 3010370			
3970228	MBC 5000/1 CT FSM 80	CT	-	-	3010222 - 3010370			
3970145	CB 512/1 - RSM 30	-	3010367	3010344	3000826 + 20064220	●	●	●
20045589	CB 512/1 CT RSM 30	CT	-	-	3000826 + 20064220	●	●	●
3970146	CB 520/1 - RSM 30	-	3010367	3010344	3000826 + 20042324			●
3970160	CB 520/1 CT RSM 30	CT	-	-	3000826 + 20042324			●
20044659	CB 525/1 - RSM 30	-	3010367	3010344	3000826 + 20042324			
20044660	CB 525/1 CT RSM 30	CT	-	-	3000826 + 20042324			
3970147	CB 5065/1 - FSM 30	-	3010367	3010344	3010221			
3970161	CB 5065/1 CT FSM 30	CT	-	-	3010221			

GAS TRAIN			VPS KIT	CQ KIT	ADAPTER			
CODE	MODEL	◆	CODE	CODE	CODE			
					RS 310	RS 410	RS 510	RS 610
3970148	CB 5080/1 - FSM 30	-	3010367	3010344	3010222			
3970162	CB 5080/1 CT FSM 30	CT	-	-	3010222			
3970149	CB 50100/1 - FSM 30	-	3010367	3010344	3010223 - 3010370			
3970163	CB 50100/1 CT FSM 30	CT	-	-	3010223 - 3010370			
20015871	CB 50125/1 - FSM 30	-	3010367	3010344	3010224			
3970196	CB 50125/1 CT FSM 30	CT	-	-	3010224			
20043035	DMV 512/1 - RSM -0	-	3010367		3000826 - 20064220	●	●	
20043036	DMV 512/1 CT RSM -0	CT	-	-	3000826 - 20064220	●	●	
20043037	DMV 512/1 CQ RSM -2	CQ	-	-	3000826 - 20064220	●	●	
20043038	DMV 520/1 - RSM -0	-	3010367	3010344	3000826 - 20042324		●	
20043039	DMV 520/1 CT RSM -0	CT	-	-	3000826 - 20042324		●	
20043040	DMV 520/1 CQ RSM -2	CQ	-	-	3000826 - 20042324		●	
20043053	DMV 525/1 - RSM -0	-	3010367	3010344	3000826 - 20042324			
20043054	DMV 525/1 CT RSM -0	CT	-	-	3000826 - 20042324			
20043055	DMV 525/1 CQ RSM -2	CQ	-	-	3000826 - 20042324			
20043041	DMV 5065/1 - FSM -0	-	3010367	3010344	3010221			
20043042	DMV 5065/1 CT FSM -0	CT	-	-	3010221			
20043043	DMV 5065/1 CQ FSM -2	CQ	-	-	3010221			
20043044	DMV 5080/1 - FSM -0	-	3010367	3010344	3010222			
20043045	DMV 5080/1 CT FSM -0	CT	-	-	3010222			
20043046	DMV 5080/1 CQ FSM -2	CQ	-	-	3010222			
20043047	DMV 50100/1 - FSM -0	-	3010367	3010344	3010223 - 3010370			
20043048	DMV 50100/1 CT FSM -0	CT	-	-	3010223 - 3010370			
20043049	DMV 50100/1 CQ FSM -2	CQ	-	-	3010223 - 3010370			
20043050	DMV 50125/1 - FSM -0	-	3010367	3010344	3010224			
20043051	DMV 50125/1 CT FSM -0	CT	-	-	3010224			
20043052	DMV 50125/1 CQ FSM -2	CQ	-	-	3010224			

- ◆ Gas valve leak detection control device:  
 - gas train not equipped with leak detection control device; this device can be ordered separately - see VPS column - and installed later.  
**CT** gas train equipped with VPS leak detection control device for burners /M.  
**CQ** gas train with pressure switch for leak detection control of burners /E.
- VPS KIT** Valve leak detection control device. Supplied separately from the gas train, on demand.  
**CQ KIT** Additional pressure switch for leak detection control in combination with burners /E.
- Gas train not available or not suitable for the matching to the burner.

## Ventilation

The ventilation unit comes with a sound proofing system.

All the burners are fitted with fans, which give excellent performance and are fitted in line with the combustion head. The air flow and sound-deadening materials used in the construction are designed to reduce sound emissions to the minimum and guarantee high levels of performance in terms of output and air pressure.

A high precision servomotor through the main management module installed on each burner, controls the air dampers position constantly.

The RS/EV is supplied with the "inverter" configuration, which means they are fitted with a device for varying the amount of combustion air through a variable speed action of the fan motor. The burner works at reduced speed, with further benefits in terms of sound emissions, especially during the night when the perception threshold is lower as well decreased power consumption.

### New ventilation structure

A new ventilation structure has been developed in order to reduce the overall dimensions and weight.



### Simplified Maintenance

for motor and fan by direct extraction through opening flange



### Air adjusting dampers

at air inlet side with ball bearings

## Combustion Head

The combustion head adjustment system allows to adapt internal geometry of the head to the output of the burner.

This system guarantees excellent mix on all firing rates range as well as reducing noise and pollutants.



Example of a RS/M BLU burner combustion head

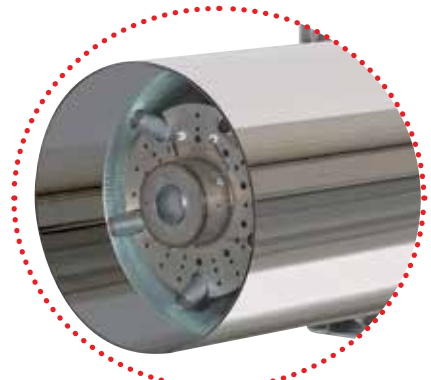

Example of a RS/M MZ burner combustion head

## Safe and Green .....

The RS BLU series reduces polluting emissions with its exclusive design which optimises air/fuel mixture.

The gas in the combustion head is distributed through openings which are perpendicular to the air flow; part of the fuel is injected directly into the centre of the flame.

This results in low flame temperature combustion to prevent the formation of NO. Gradual and progressive combustion throughout the flame prevents areas of high oxidation inside the flame.

Emissions are further reduced by the re-circulation of combustion gases due to the high velocity of air leaving the combustion head.

Pollution levels are below even the most severe standard requirements.

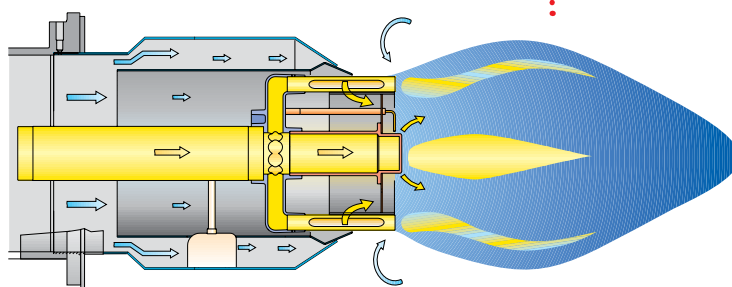

### SUGGESTED COMBUSTION CHAMBER DIMENSIONS

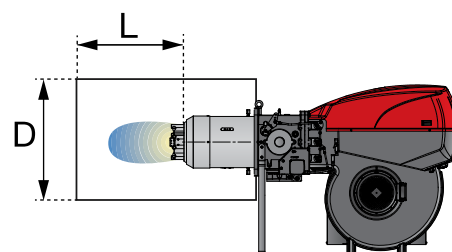
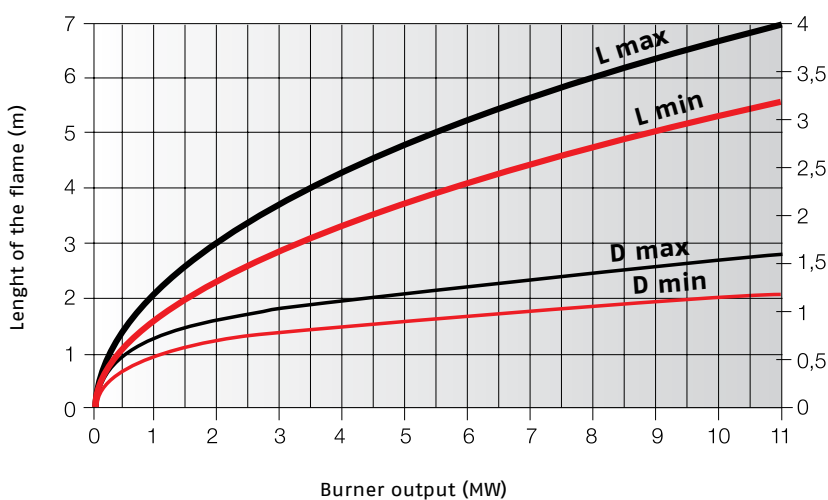

Example:  
 Burner thermal output = 6000 kW;  
 L Combustion Chamber (m) = 4,7 m (medium value);  
 D Combustion Chamber (m) = 1,2 m (medium value)



**NO<sub>2</sub> EMISSIONS (RS BLU MODELS)**

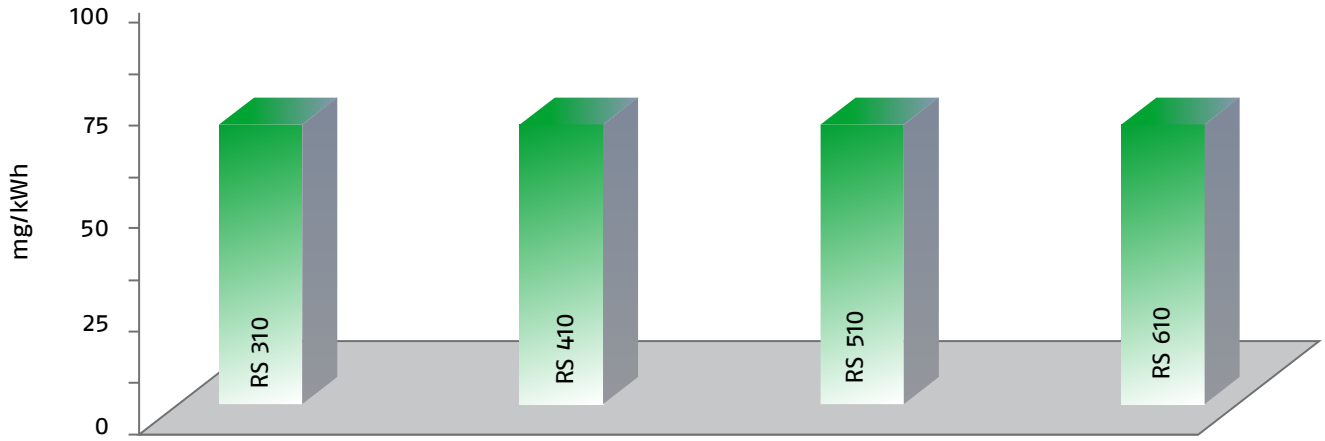

**CO EMISSIONS (gas G20) (RS BLU and MZ MODELS)**

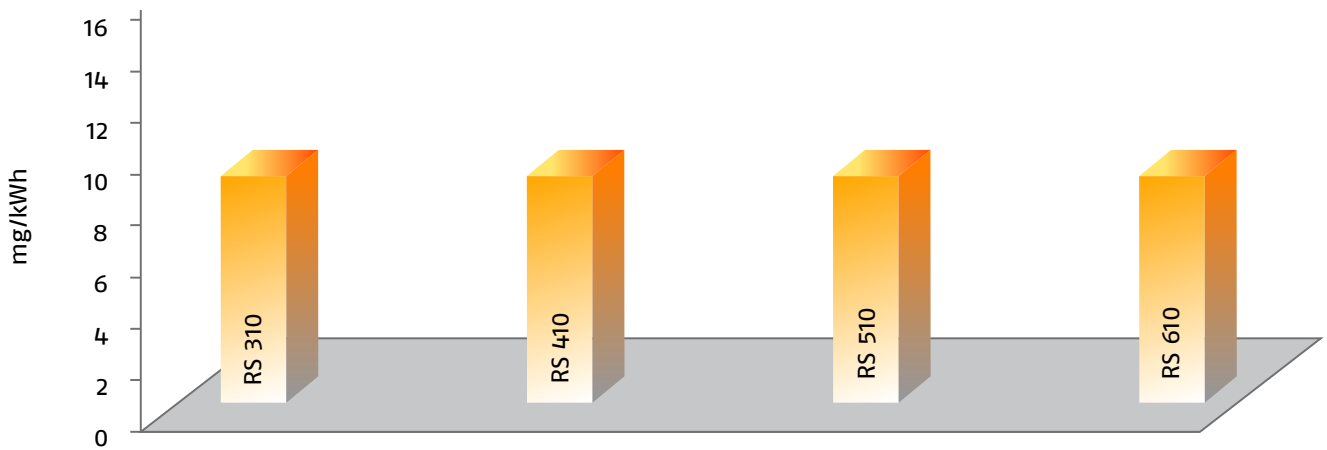

**NOISE EMISSIONS (RS BLU and MZ MODELS)**

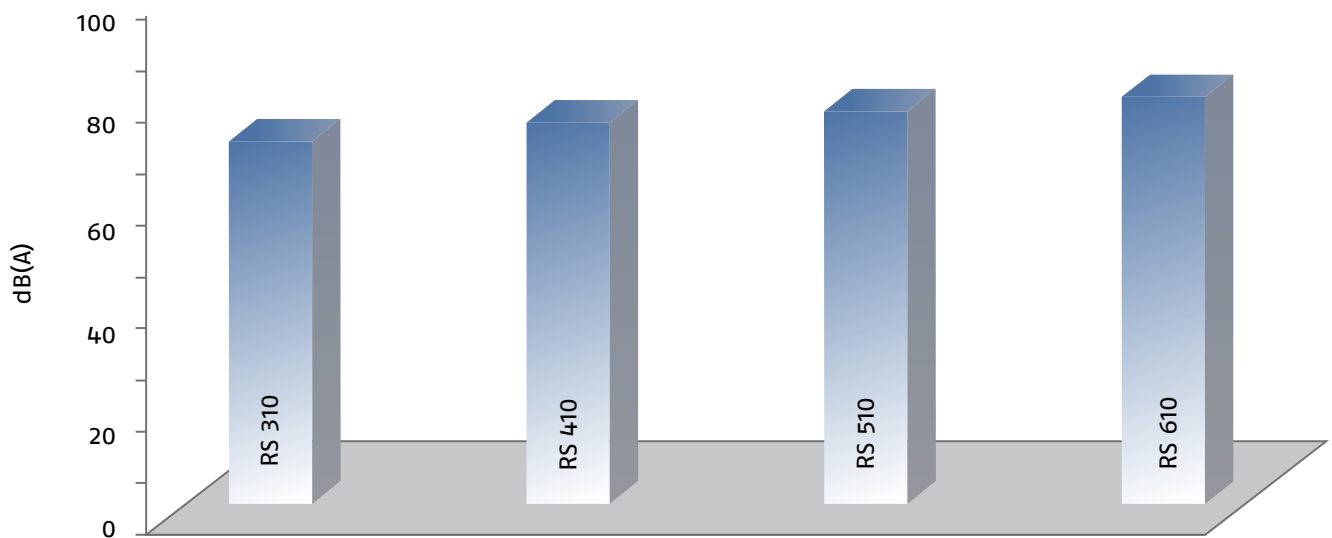

The noise emissions have been measured at the maximum output.



# Operation

## BURNER OPERATION MODE

The RS 310-410-510-610/M series of burners can have "two-stage progressive" or "modulating" operation.



Output regulator



Analog 4-20 mA or 0 - 10V converter for remote modulation

On "two-stage progressive" operation, the burner gradually adapts the output to the requested level, by varying between two pre-set levels (see picture A).

On "modulating" operation, normally required in steam generators, in superheater boilers or diathermic oil burners, a specific regulator and probes are required. These are supplied as accessories that must be ordered separately. The burner can work for long periods at intermediate output levels (see picture B).

### "TWO-STAGE PROGRESSIVE" OPERATION

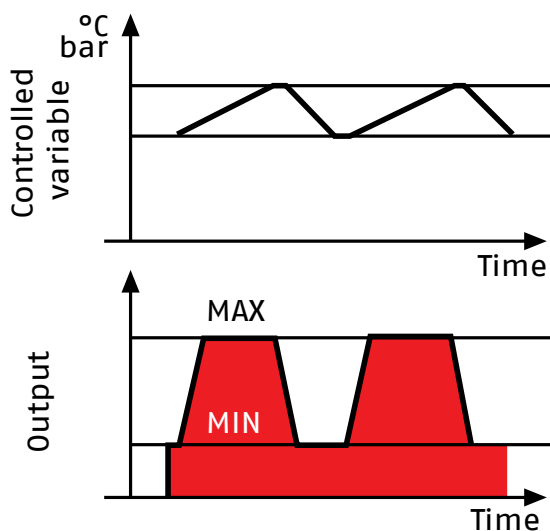

Picture A

### "MODULATING" OPERATION

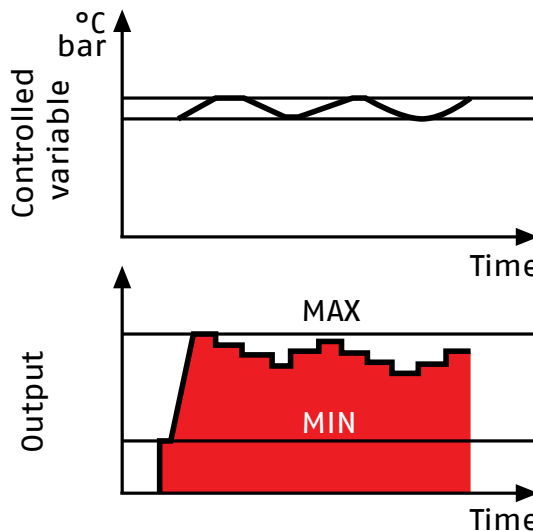

Picture B

The RS 310-410-510-610/M series burners are fitted with the LFL 1.333 or RMG88.62 C2 microprocessor control panel for the supervision during intermittent operation. The FS2 burners are fitted with the LGK16.333A27 control panel. For helping the commissioning and maintenance work, on the RMG/M control box, there are two main elements:



RMG 88.62 C2



The lock-out reset button is the central operating element for resetting the burner control and for activating / deactivating the diagnostic functions.

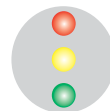

The multi-color LED is the central indication element for visual diagnosis and interface diagnosis.

Both elements are located under the transparent cover of lock-out reset button, as shown in the picture above.

There are two diagnostic choices, for indication of operation and diagnosis of fault cause:

**VISUAL DIAGNOSIS**



**INTERFACE DIAGNOSIS**

By the interface adapter and a PC with dedicated software or by a predisposed flue gas analyzer (see paragraph accessories).

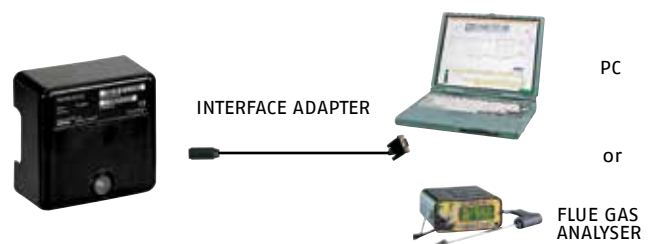

**REC27 and REC37  
Digital Burner Management System**

Combustion systems are in continuous evolution and high tech solutions, in particular connected to electronic systems, are today applied in order to obtain better performances and efficiencies. The Burner is one of the most important component of the combustion system and its evolution is in the direction of the perfect control of operation and more efficiency. Following this evolution trend RIELLO RS 310-410-510-610/E-/EV gas burner series has been upgraded with the introduction of new models with modulating operation obtained by Electronic Cam. The new models are based on the Digital Burner Management Systems RIELLO REC27 and REC37, which are able to manage the air-fuel ratio by independent servomotors in order to obtain a perfect output control and to assure a correct combustion and safe operation on all modulation range.

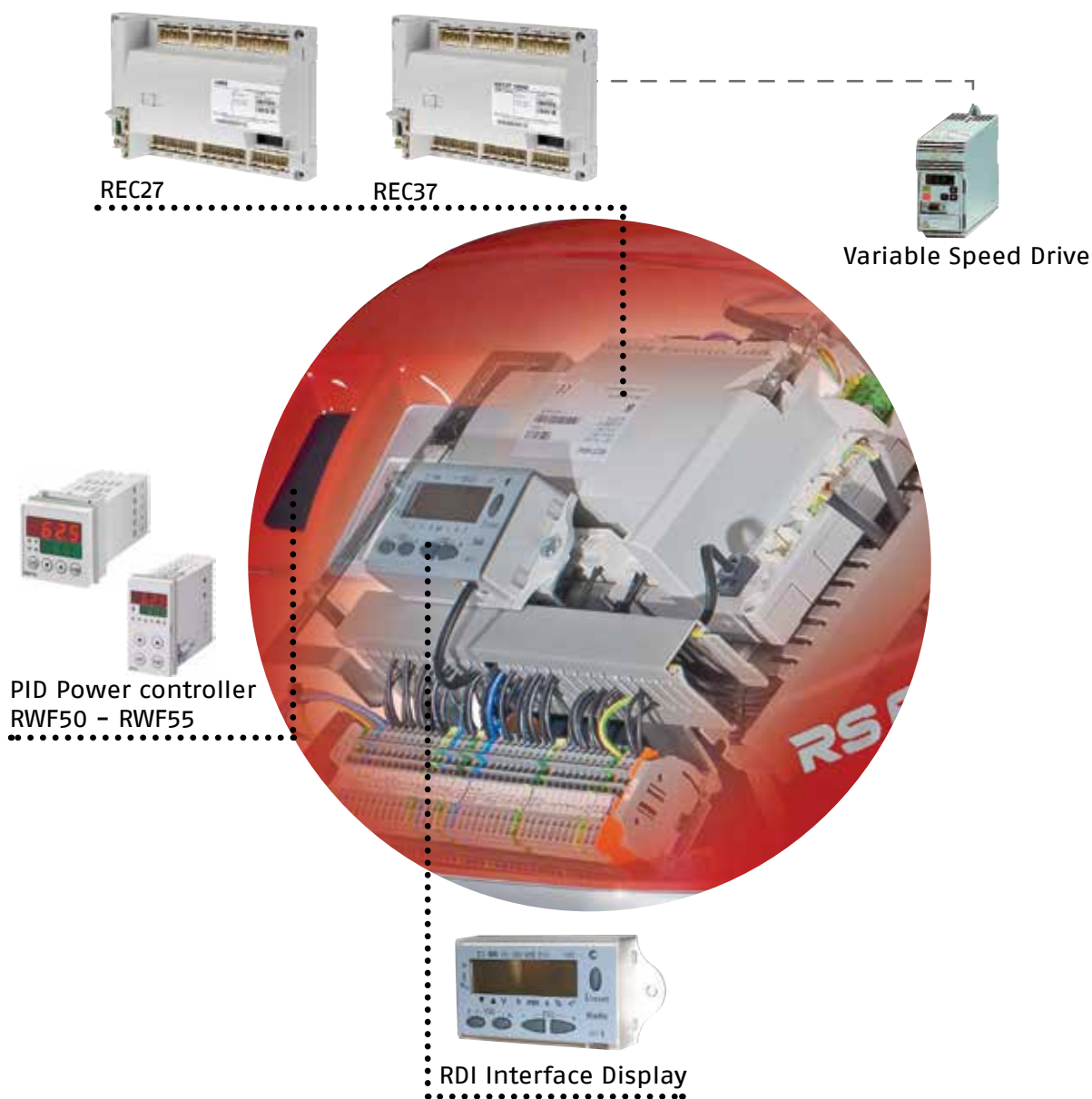

**REC ELECTRONIC CAM SYSTEM**

The family line that includes the REC27 Digital Burner Management System has been upgraded with the introduction of the REC37 version suitable for continuous operation, variable speed drive operation and with 4/20 mA remote analogue control signal.

Function	Digital Burner Management System Model	
	REC27	REC37
Intermittent	●	●
Continuous operation		●
Two stage progressive operation	●	●
Modulating operation with the installation of a PID electronic regulator	●	●
Variable speed drive operation		●
Valve proofing system	●	●
Air fuel mixing control	●	●
Independent Ignition Point Position	●	●
Closed air damper during burner stand-by	●	●
Password protection levels	●	●
Burner status display	●	●
Error message	●	●
Error hystory	●	●
Remote lockout reset	●	●
Continuous Ventilation	●	●
Start without pre-purging	●	●
Remote Connections by external OCI410-412 modules	●	●
4/20 mA Remote Analogue Control signal		●
Indication of current burner output DC 0 ... 10 V	●	
Indication of current burner output DC 0 ... 10 V (alternative to VSD control)		●

**FAN SPEED CONTROL (ON DEMAND)**

The inverter device fitted to the RS/EV series burner acts on the electrical supply frequency of the fan motor to adjust the air flow through the motor speed variation.

The main advantages of speed control:

- lower sound emissions
- electric power saving.

The fan motor supplies just the necessary air flow, thus reducing sound emissions and avoiding energy loss due to the air damper regulation mechanism. The inverter technology can save up to 35% of the energy costs. A safety device to verify the correct speed of the motor is mounted on the air suction circuit of the burner.

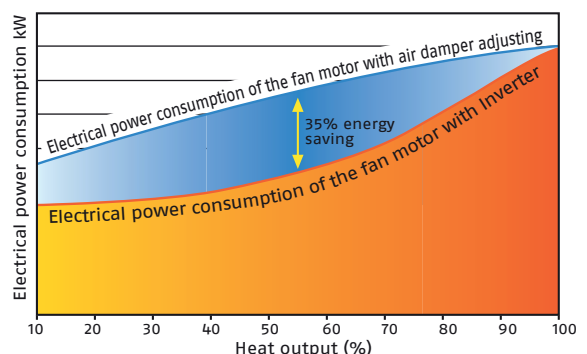

## Overall Dimensions (mm)

BURNERS RS 310-410-510-610/M-/E-/EV BLU

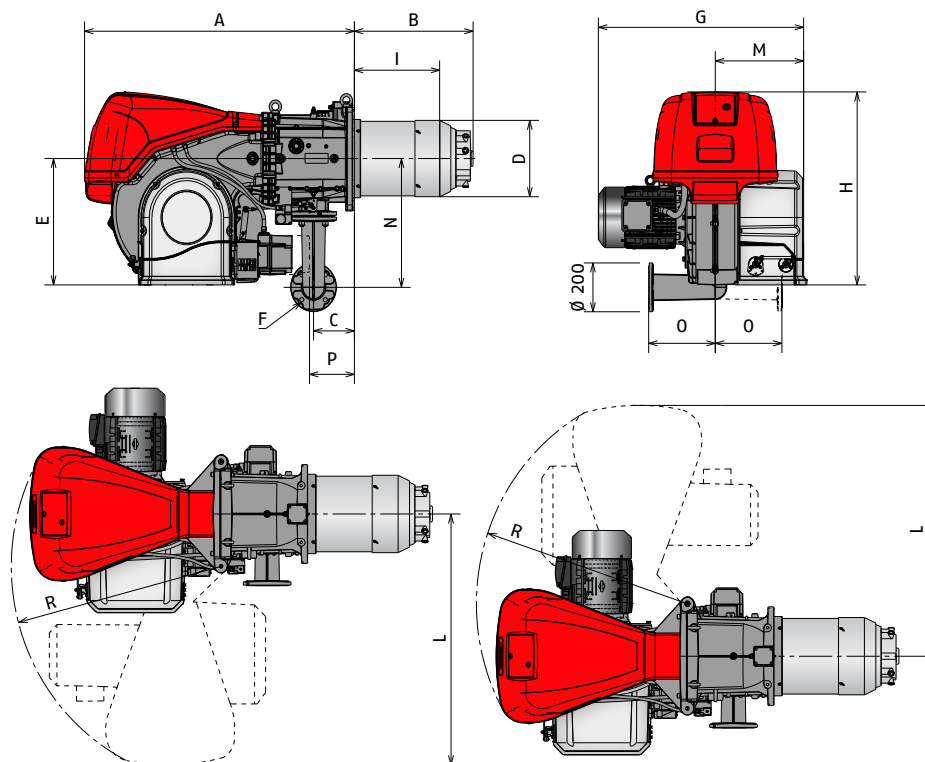

MODEL	A	B	C	D	E	F**	G	H	I	L	M	N	O	P*	R
RS 310 BLU	1178	465	178	306	520	DN65	890	790	346	1015	400	528	290	177	890
RS 410 BLU	1178	517	178	313	520	DN65	908	790	340	1015	400	528	290	177	890
RS 510 BLU	1178	517	178	313	520	DN65	908	790	340	1015	400	528	290	177	890
RS 610 BLU	1178	517	178	334	520	DN65	980	790	365	1015	400	528	290	177	890

\* Maximum position for the extraction of the servomotor cover in mechanical cam models.

\*\* The gas adaptor is set also for DN 80 bore.

### BURNER - BOILER MOUNTING FLANGE

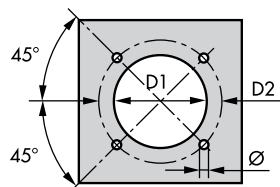

MODEL	D1	D2	Ø
RS 310 BLU	335	452	M18
RS 410 BLU	335	452	M18
RS 510 BLU	335	452	M18
RS 610 BLU	350	452	M18

### PACKAGING

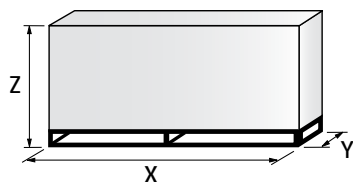

MODEL	X	Y	Z	kg
RS 310 BLU	2040	1180	1125	250
RS 410 BLU	2040	1180	1125	250
RS 510 BLU	2040	1180	1125	250
RS 610 BLU	2040	1180	1125	280

**BURNERS RS 310-410-510-610/M-/E-/EV MZ**

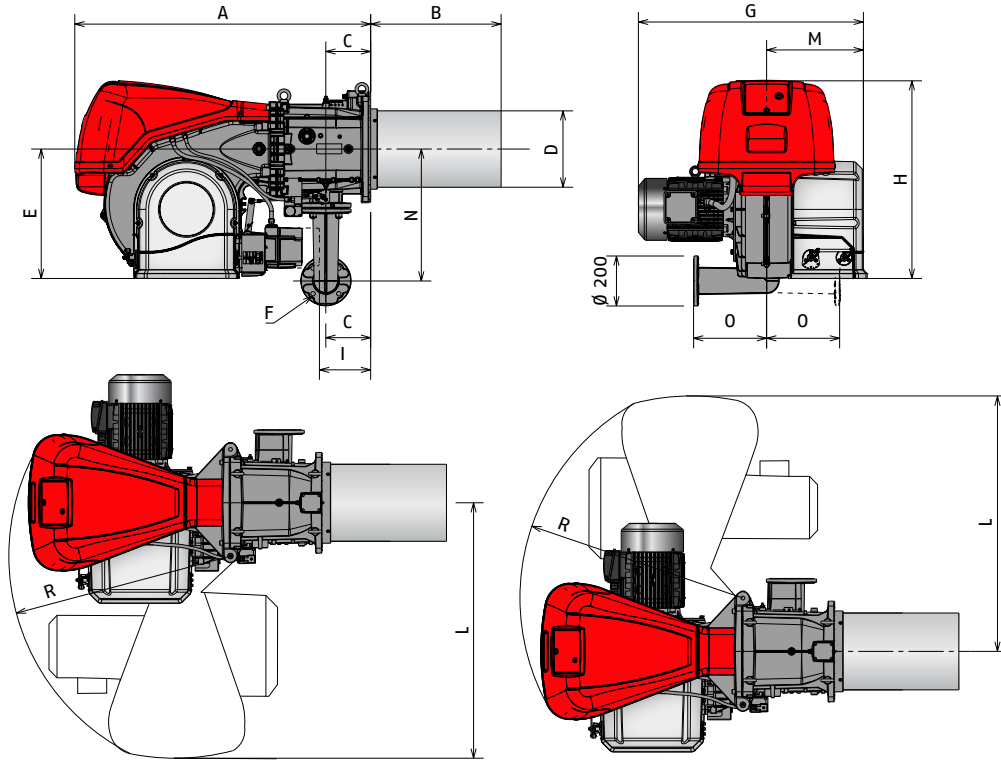

MODEL	A	B	C	D	E	F**	G	H	I*	L	M	N	O	P	R
RS 310 MZ	1178	519	178	306	520	DN65	890	790	177	1015	400	528	290	177	890
RS 410 MZ	1178	519	178	306	520	DN65	908	790	177	1015	400	528	290	177	890
RS 510 MZ	1178	519	178	306	520	DN65	908	790	177	1015	400	528	290	177	890
RS 610 MZ	1178	500	178	330	520	DN65	980	790	177	1015	400	528	290	177	890

\* Maximum position for the extraction of the servomotor cover in mechanical cam models.

\*\* The gas adaptor is set also for DN 80 bore.

**BURNER - BOILER MOUNTING FLANGE**

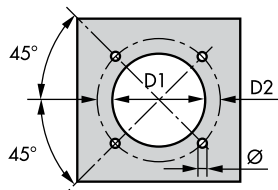

MODEL	D1	D2	Ø
RS 310 MZ	335	452	M18
RS 410 MZ	335	452	M18
RS 510 MZ	335	452	M18
RS 610 MZ	350	452	M18

**PACKAGING**

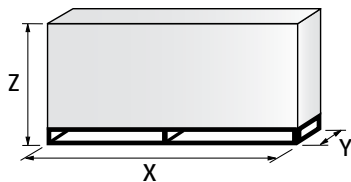

MODEL	X	Y	Z	kg
RS 310 MZ	2040	1180	1125	250
RS 410 MZ	2040	1180	1125	250
RS 510 MZ	2040	1180	1125	250
RS 610 MZ	2040	1180	1125	280

## Burner accessories

### Accessories for modulating operation

#### POWER CONTROLLER



To obtain modulating operation, the RS/M BLU series of burners requires a regulator with three point outlet controls. The following table lists the accessories for modulating operation with their application range.

BURNER	TYPE	CODE
RS 310-410-510-610/M	RWF 50.2 - Basic version with 3 position output	20073595
RS 310-410-510-610/E-/EV	RWF 50.2 - Basic version with 3 position output	20085417
All models	RWF 55.5 - Complete with RS-485 interface	20074441
	RWF 55.6 - Complete with RS-485/PROFIBUS interface	20074442

#### PROBE



The relative temperature or pressure probes fitted to the power controller must be chosen on the basis of the application.

BURNER	TYPE	RANGE (°C) (bar)	CODE
All models	Temperature PT 100	-100 ÷ 500°C	3010110
	Pressure 4 ÷ 20 mA	0 ÷ 2,5 bar	3010213
	Pressure 4 ÷ 20 mA	0 ÷ 16 bar	3010214
	Pressure 4 ÷ 20 mA	0 ÷ 16 bar	3090873

#### ANALOG CONTROL SIGNAL CONVERTER



BURNER	TYPE (INPUT SIGNAL)	CODE
RS 310-410-510-610/M	0/2 - 10 V (impedance 200 KΩ) 0/4 - 20 mA (impedance 250 Ω)	20074479

#### POTENTIOMETER

BURNER	CODE
RS 310-410-510-610/M	20074487

#### CONTINUOUS VENTILATION KIT



If the burner requires continuous ventilation in the stages without flame, a special kit is available as given in the following table:

BURNER	CODE
RS 310-410-510-610/M	20074542
RS 310-410-510-610/E	20077810

**UV CELL KIT**



A UV cell is available for the supervision of the flame alternatively to ionisation probe for special applications.

BURNER	CODE
RS 310-410-510-610/M	20074548
RS 310-410-510-610/E-/EV	20077814

**PC INTERFACE KIT**



To connect the control panel to a personal computer for the transmission of operation, fault signals and detailed service information, an interface adapter with PC software are available.

BURNER	CODE
RS 310-410-510-610/M	3002719
RS 310-410-510-610/E-/EV (ACS410 + OCI410.30) - Service level	3010436

**OCI412 INTERFACE KIT**



Interface kit between the REC 27.1 and a Modbus system, such as a building automation and control system (BACS). The Modbus interface is based on the RS-485 standard.

BURNER	CODE
RS 310-410-510-610/E-/EV	3010437

**SOUND PROOFING BOX**

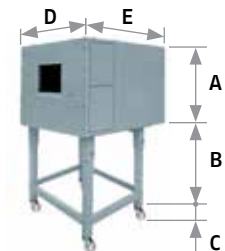

If noise emission needs reducing even further, sound-proofing boxes are available. In case of generator heights, where a lower dimension "B" is required, ask for the Box Support Kit code 20065135. The useful dimensions are 40 mm less than the total dimensions indicated in the table (A, D, E). Not suitable for outdoor use.

BURNER	BOX TYPE	A (mm)	B (mm) min. - max.	C (mm)	D (mm)	E (mm)	[dB(A)] (*)	CODE
All models	C7	1255	160 - 980	110	1140	1345	10	3010376

(\*) Average noise reduction according to EN 15036-1 standard

**SPACER KIT**



If burner head penetration into the combustion chamber needs reducing, varying thickness spacers are available, as given in the following table:

BURNER	SPACER THICKNESS S (mm)	CODE
All models	180	20008903



**VARIABLE SPEED DRIVE (VSD) FOR RS/EV SERIES ONLY**

The motor speed variation for the RS/EV BLU burners series is obtained thanks to a frequency converter: variable speed drive (VSD) provided with a programming panel with start-up assistant.

BURNER	VOLTAGE	MOTOR POWER (kW)	INVERTER POWER (kW)	CODE
RS 310/EV	230V	7.5	7.5	20083590
RS 310/EV	400V	7.5	7.5	20028307
RS 410/EV	230V	9.2	11	20083611
RS 410/EV	400V	9.2	11	3090952
RS 510/EV	400V	12	15	3090960
RS 610/EV	400V	15	15	3090960



The use of inverters other than those indicated by the Manufacturer may lead to burner failure and, in extreme cases, a potential risk of harm to people and damage to property. The manufacturing company shall not be liable for any such damage arising from non-observance of the requirements contained in the burner manual.

## Gas train accessories

### ADAPTERS

In certain cases, an adapter must be fitted between the gas train and the burner, when the diameter of the gas train is different from the set diameter of the burner.

Below are given the available adapters; please see on the Gas Train list the correct adapter codes to select.

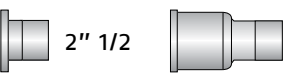
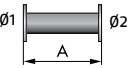
ADAPTER	DIMENSIONS				ADAPTER CODE
	Ø1 DN	Ø2 DN	A mm	B mm	
1" 1/2  2"	-	-	65	-	20064220
2"  2"	-	-	65	-	20042324
DN 80  2"	-	-	300	-	3000826
	65	80	400	-	3010221
	80	80	400	-	3010222
	100	80	400	-	3010223
	125	80	320	-	3010224

### PVP (PRESSURE VALVE PROVING KIT)\*

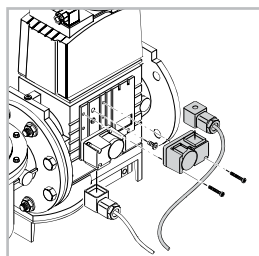

The seal control function is included on Burner Digital Management System, it is only necessary to add the PVP kit on the gas train.

GAS TRAIN	CODE
MB - CB - DMV type	3010344

\* not necessary for those models where is included as a standard.

## SEAL CONTROL KIT



To test the valve seals on the gas train, a special "seal control kit" is available. The valve seal control device is compulsory (EN 676) on gas trains to burners with a maximum output over 1200 kW. The seal control is type VPS 504.

GAS TRAIN	KIT CODE for 50 Hz operation
MB type	3010123
MCB - CB - DMV type	3010367

## STABILISER SPRING



To vary the pressure range of the gas train stabilisers, accessory springs are available. The following table shows these accessories with their application range. Please refer to the technical manual for the correct choice of spring.

GAS TRAIN	SPRING COLOUR	SPRING PRESSURE RANGE mbar	SPRING CODE
MBC 1900/1 - 3100/1 MBC 5000/1	White	4 - 20	3010381
	Red	20 - 40	3010382
	Black	40 - 80	3010383
CB 512/1	Green	80 - 150	3010384
	Red	25 - 55	3010131
	Black	60 - 110	3010157
CB 520/1 - 525/1	Pink	90 - 150	3090486
	Red	25 - 55	3010132
	Black	60 - 110	3010158
CB 5065/1 - 5080/1	Pink	90 - 150	3090487
	Red	25 - 55	3010133
	Black	60 - 110	3010135
CB 50100/1	Pink	100 - 150	3090456
	Grey	140 - 200	3090992
	Red	25 - 55	3010134
CB 50125/1	Black	60 - 110	3010136
	Pink	100 - 150	3090489
	Grey	140 - 200	3092174
	Red	25 - 55	3010315
	Yellow	30 - 70	3010316
	Black	60 - 110	3010317
	Pink	100 - 150	3010318

# Specification

## DESIGNATION OF SERIES

A specific index guides your choice of burner from the various models available in the RS/M C13 series. Below is a clear and detailed specification description of the product.

Series: R									
Fuel: S Natural Gas									
L Light oil									
LS Light oil/Natural Gas									
N Heavy oil									
Size:									
Setting: /1 Single stage					/E Electronic cam				
/B Two stage					/P Proportioning air/gas valve				
/M Modulating-Mechanical cam					/EV Electronic cam predisposed for variable speed (with inverter)				
Emission: ... or CO1					Class 1 EN267 - EN676				
MZ					Class 2 EN267 - EN676				
BLU					Class 3 EN267 - EN676				
MX					Class 2 EN267				
					Class 3 EN676				
Head length: TC standard head									
TL extended head									
Flame control system: FS1 Standard/Intermittent (at least 1 stop every 24 h)									
FS2 Continuous (1 stop every 72 h)									
Electrical supply to the system:									
1/230/50					1/230V/50Hz				
3/230/50					3/230V/50Hz				
3/400/50					3N/400V/50Hz				
3/230-400/50					3/230V/50Hz - 3N/400V/50Hz				
3/220/60					3/220V/60Hz				
3/380/60					3N/380V/60Hz				
3/220-380/60					3/220/60Hz - 3N/380V/60Hz				
Auxiliary voltage: 230/50-60 230V/50-60H									
110/50-60 110V/50-60Hz									

R	S	510	/M	BLU	TC	FS1	3/230-400/50	230/50-60	
BASIC DESIGNATION				EXTENDED DESIGNATION					

**STATE OF SUPPLY**

Monoblock forced draught gas burner with modulating operation, fully automatic, made up of:

- High performance fan with low sound emissions, forward curve blades.
- Air suction circuit lined with sound-proofing material
- Air damper for air setting controlled by a high precision servomotor
- Air pressure switch
- Fan starting motor at 2900 rpm, three-phase 230/400 - 400/690 V with neutral, 50 Hz
- Combustion head, that can be set on the basis of required output, fitted with:
  - stainless steel end cone, resistant to corrosion and high temperatures
  - ignition electrodes; ionisation sensor for flame detection (or UV sensor on demand)
  - flame stability disk
- Maximum gas pressure switch, with pressure test point, for halting the burner in the case of over pressure on the fuel supply line
- Burner safety control box for controlling the system safety: RMG/M and LFL for FS1 intermittent operation and LGK for FS2 continuous operation for RS 310-410-510-610/M models; REC27 for FS1 intermittent operation for RS 310-410-510-610/E models; REC37 for FS2 continuous operation for RS 310-410-510-610/E models and intermittent/continuous operation for RS 310-410-510-610/EV models
- Star/Delta starter for the fan motor (Direct starter fan motor for RS 310-410 models)
- Main electrical supply terminal board
- Burner on/off switch
- Manual or automatic output increase/decrease switch
- Contacts motor and thermal relay with release button
- Burner failure led signal and lighted release button
- Burner opening hinge
- Lifting rings
- IP 54 electric protection level

**Standard equipment:**

Gasket for gas train adaptor

Adaptor for gas train

Screws for fixing the gas train adaptor: M 16 x 70

Thermal insulation screen

M 18 x 60 screws to secure the burner flange to the boiler

Cable grommets kit for optional electrical wiring input

M16 x 6 studs for fixing the gas elbow to the pipe coupling

M16 nuts to fix the gas elbow to the pipe coupling

Seal control pressure switch for installation on gas train for /E - /EV models

Instruction handbook for installation, use and maintenance

Spare parts catalogue

**Gas train**

Fuel supply line, in the MULTIBLOC configuration (for a diameter of 1-1/2" and 2") or COMPOSED configuration (from a diameter of DN 65 until a diameter of DN 125), fitted with:

- Filter
- Stabiliser
- Minimum gas pressure switch
- Safety valve
- One stage working valve with ignition gas output regulator.

**Conforming to:**

- 2004/108 EC directive (electromagnetic compatibility)
- 2006/95 EC directive (low voltage)
- 2009/142 EC directive (gas)
- 2006/42 EC directive (machine)
- EN 676 (gas burners).

**Available accessories to be ordered separately:**

- Power controller
- Probe
- Analog control signal converter
- Potentiometer
- Continuous ventilation kit
- UV cell kit
- PC interface kit
- OCI412 Interface kit
- Sound proofing box
- Spacer kit
- Variable Speed Drive (VSD) for RS/EV series only
- Adapters
- PVP (Pressure Proving System)
- Seal Control kit
- Stabiliser spring.





The pictures are purely indicative and for information.

RIELLO S.p.A. - 37045 Legnago (VR)  
Tel. +39.0442.630111 - Fax: +39.0442.21980  
[www.riello.com](http://www.riello.com)

Since the Company is constantly engaged in the production improvement, the aesthetic and dimensional features, the technical data, the equipment and the accessories can be changed. This document contains confidential and proprietary information of RIELLO S.p.A. Unless authorised, this information shall not be divulged, nor duplicated in whole or in part.

**RIELLO**